

Operating and Maintenance Instructions

Mira LED Procedure Exam Light Wall Mount



Amico

Contents

Introduction	3
Symbols Used in This Manual	4
Safety Instructions	5
Intended Use	5
User Profiles	5
Safety Instructions	5
Specific Fitting Instructions	6
Warning Levels	6
Scope of Delivery	7
Installing the Wall Mount	8
Install the Locking Rings	10
Uninstall the Locking Rings	10
Installing the Lighthead	12
Operation	15
Disinfecting, Cleaning and Sterilization	16
Maintenance	17
Notes on the Arm Systems	18
Selection of Fastening Material	18
Cleaning and Disinfection	18
Testing	18
Disassembling for Servicing	19
Spare Parts	20
Troubleshooting	20
Disassembling for Servicing	21
Technical Data of the Lighthead	22
Technical Data of the Arm System	23
Warranty	23

Introduction

Congratulations and thank you for your purchase of the Amico Mira LED Procedure Exam Light.

To ensure proper functionality and performance of the Mira Light please read the following instructions very carefully before installing the fixture. Keeping safety in mind please follow the safety instructions and requirements included in this document. The installation instructions provided are for Amico's standard products. Slight modifications to the installation may be required for custom configurations and wall conditions.

If you need information for further instructions on operation, maintenance, and/or descriptions of the product please feel free to contact Amico's Customer Service at: alt-customerservice@amico.com













For technical support please contact: alt-techsupport@amico.com

The product shipped to the job site may not be exactly as shown in the installation drawings.

To learn more about Amico's portfolio of healthcare lighting products, visit <https://www.amico.com/lights>

Symbols Used in This Manual

The warning symbols indicate all instructions that are important for safety. Failure to comply with them can lead to injury, damage to the luminaire or the equipment. In combination with the following signal words the warning symbols means:

 DANGER	Can lead to death or serious injury
 WARNING	Can lead to injury
 CAUTION	Can lead to damage to property
	Comply with operating instructions
	CE conformity mark
	Protective conductor
N	Neutral conductor/return conductor for the electrical current
L1	Live conductor
	Storage humidity
	Storage temperature
	Disposal
	Manufacturer
	Read manual
	Do not step
	Do not lean

Trademarks: All trade names mentioned in these instructions are the exclusive property of the relevant manufacturers.

Safety Instructions

Intended Use

The Mira LED Procedure Exam Light is intended to provide illumination for minor procedures, diagnosis, or examinations. It is to be used near the patient to support treatments, which pose no risk to the patient in the event of any interruption caused by light failure. It is meant for continuous operation.

User Profiles

Medical Staff

All persons with medical training who work in the field for which they were trained.

Cleaning Staff

All persons familiar with national and workplace hygiene requirements.

Electricians

All persons with training in electronics and electrical technology who are familiar with the relevant standards and regulations.

Certified Installers

Persons qualified by training, experience and knowledge of the regulations to install and remove the equipment

Safety Instructions

Please note that certain duties must be carried out by people with the appropriate corresponding qualifications. The instructions are part of the product and must be kept so they are accessible for all subsequent users:

- These instructions are for the Amico Mira LED Procedure Exam Lights. This includes wall mounted equipment.
- Please carefully read these operating instructions before using the equipment. It will help protect you and others from potential injuries that may occur.
- All work on the light (including repairs) must be done by qualified electricians only. The light must be installed by a certified installer.
- The light must not be modified or manipulated. Use in any other manner than with the original parts may result in different specifications and life-threatening dangers.
- Only persons with medical training are permitted to operate the equipment.
- Only trained cleaning personnel are permitted to clean the equipment.
- The light must not be used in an explosive environment. The power supply to the light is a potential ignition source.
- The light must be used in dry rooms only.
- The light must not be left on unattended.
- Keep all flammable equipment and objects away from the Lighthouse and cone during use.
- Do not use a damaged light. Defective cables can also be a potential hazard. Do not position cables near heat sources or sharp edges.
- Eye damage. Never look directly at the light cone.
- Replace damaged lenses before using the light again.
- The light must be connected to the mains with a protective earth to prevent electric shock.

Safety Instructions

- Never apply additional loads to the Lighthouse and spring arm.
- Do not cover the light with a cloth or similar material while operating.
- If problems are encountered that have not been addressed in these operating instructions, please contact your supplier in the interest of your own safety.

Please keep these operating instructions in a secured place near the device. This ensures easy access to safety instructions and important information should the need arise.

- The inspections and maintenance work, as described on page 17, should only be done by trained service technicians. Anyone else is not authorized to perform inspections and maintenance work.
- The adjustment work should only be carried out by a hospital technician or someone with similar qualifications. Anyone else is not authorized to perform adjustment work.
- This equipment has been built accordingly and is operationally safe. Nonetheless, it may still present some danger, especially if not used according to the operating instructions as specified in this manual.
- Modifications are never to be made for any reason. This is to ensure safety for all persons involved. Any modifications made to the system void the warranty.
- The contents of the operating instructions are subjected to change without notice.

Specific Fitting Instructions

Mira LED Procedure Exam Light - Wall Mount

- Mounting material not included in delivery.

The light may be mounted only on walls that guarantee sufficient hold. The necessary technical information can be found in the installation section of this manual.

Warning Levels

DANGER

Indication of hazards that can lead to death or serious injury if measures are disregarded.

WARNING

Indication of hazards that can lead to injury if measures are disregarded.

CAUTION

Indication of hazards that can lead to damage to property if measures are disregarded.

EXPLOSION HAZARD

Non-compliance with this symbol may result in damages or injuries due to explosion.

ELECTRIC SHOCK

Non-compliance with this symbol may result in damages or injuries due to electric shock.

Scope of Delivery

Included Hardware

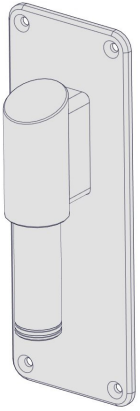

1x Wall Mount

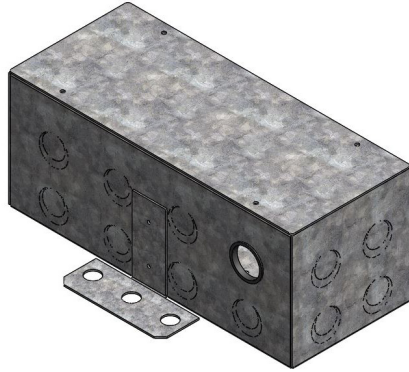

1x Electrical Box

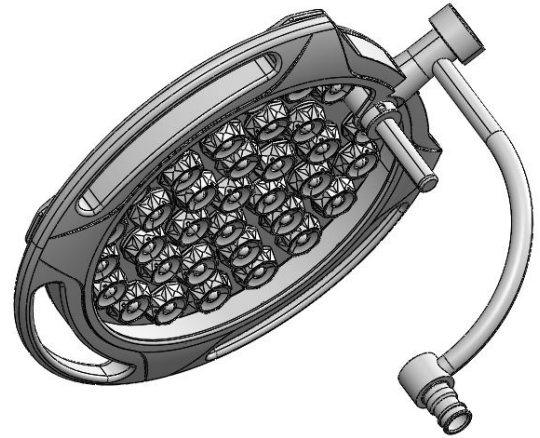

1x Lighthead

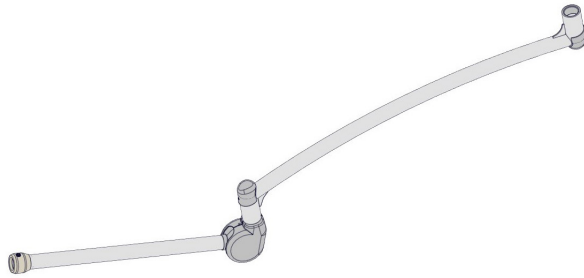

1x Arm

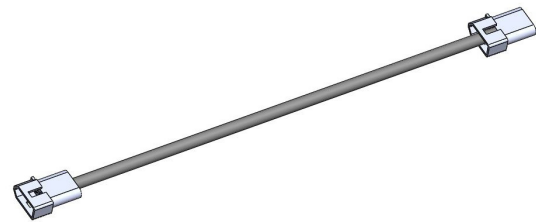

1x Cable 8 Harness



1x Shim

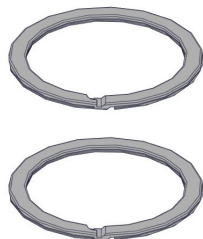

2x Locking Ring

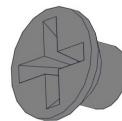

1x #4 Phillips Screw

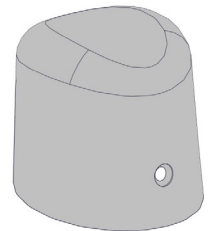

1x Corner Cap

Installing the Wall Mount

Load Data

Bending Moment MB	max. 210 Nm
Vertical Weight Forces FG	max. 205 N

- 1x load only. Regional safety factors to be considered.
- Maximum device load is assumed and included.

Warnings When Installing the Wall Mount

WARNING

TO BE FITTED ONLY BY QUALIFIED PERSONNEL

- Installation may be carried out by a state-certified fitter. Insufficient professional knowledge could cause life-threatening injury.

ELECTRIC SHOCK

DANGER OF DEATH FROM ELECTRIC SHOCK

- All-pole disconnection of the light from the mains by an external switch must be possible.

Installing the Wall Mount

WARNING

DANGER OF INJURY FROM UNFOLDING SPRING ARM

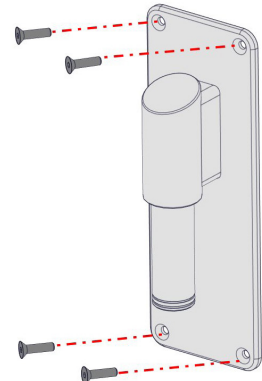
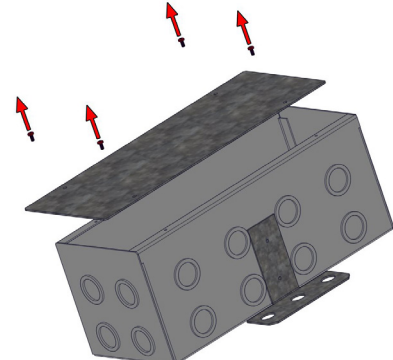
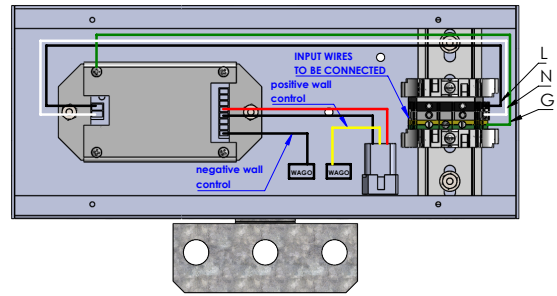
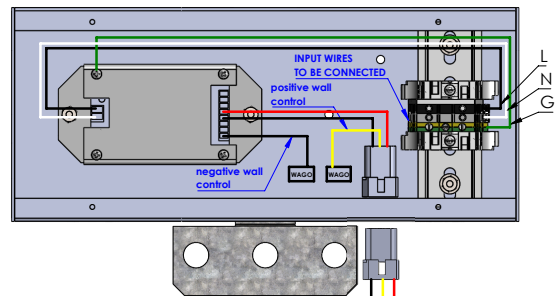
1.	Mount the wall mount using 1/4" flathead screws. Ensure fasteners are adequate for load and site.	
2.	Remove screws from the electrical box and open the cover.	
3.	Connect Input to terminal block in the electrical box. Use one of cut out for conduit connector. (Picture is an example location.)	
4.	Connect the main supply to the wire from the drop tube, using grommet that provided. Put the cover back on after installation.	

Installing the Wall Mount

WARNING

DANGER OF INJURY FROM UNFOLDING SPRING ARM

5. Install the ceiling arm. Then, install the shim and two locking rings.

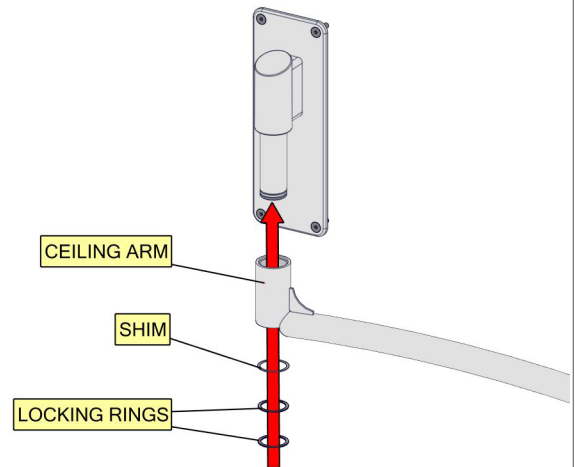

Install the Locking Rings

1. Separate the multiple coils and inset an end into the groove.
2. Press down around the circumference and wind the ring into the groove.



Uninstall the Locking Rings

1. Insert a screwdriver (or similar flat object) into removal notch.
2. Use tool to pry out first end of ring.
3. Grab ring and spiral it out of the groove.



Installing the Wall Mount

WARNING

DANGER OF INJURY FROM UNFOLDING SPRING ARM

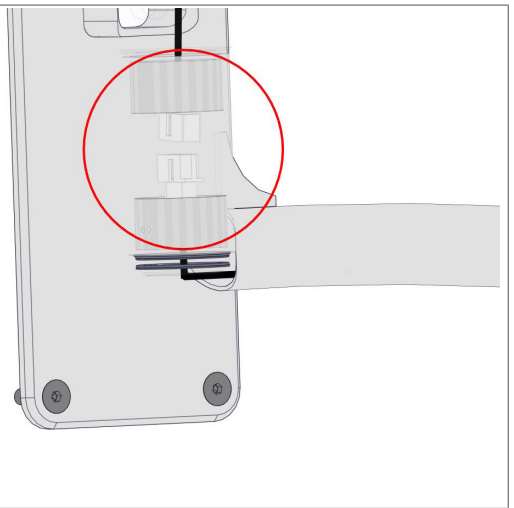
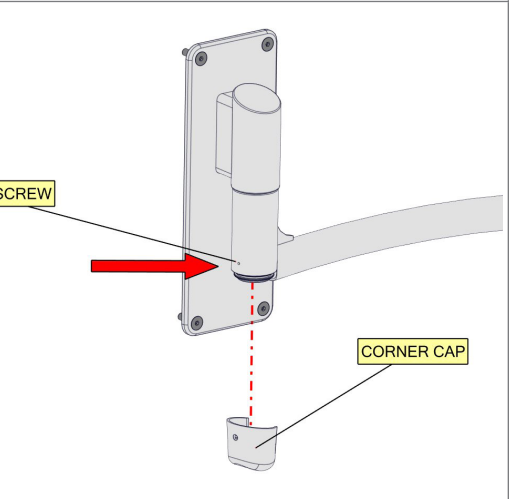
6.	Connect the power cable from the extended arm to the cable from the wall mount.	
7.	Secure the corner cap using the given #4 Philips Screw.	

Installing the Lighthouse

CAUTION

DAMAGE CAN BE CAUSED BY FALLING LIGHTHEAD

DANGER OF INJURY THROUGH INCORRECT FITTING OF THE LIGHTHEAD

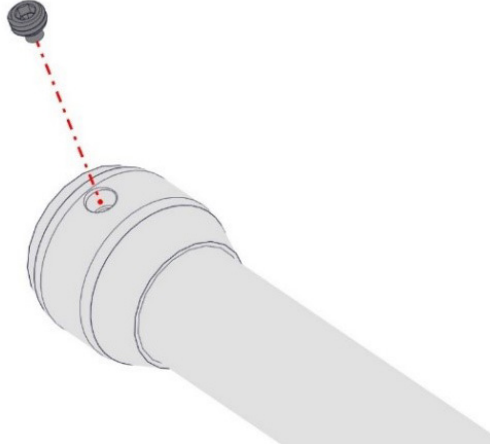
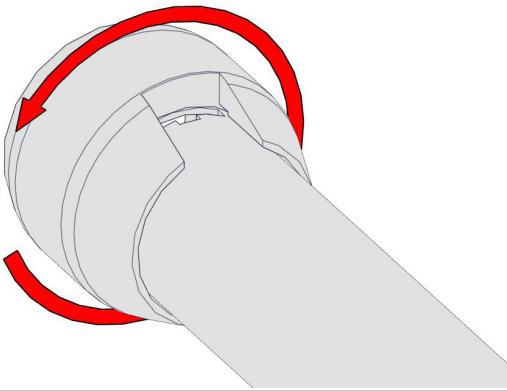
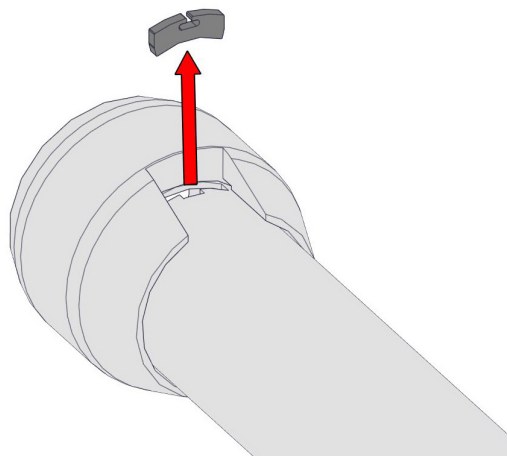
1.	Remove the screw.	
2.	Rotate the sleeve so the notch and slot are aligned.	
3.	Take out the safety segment.	

Installing the Lighthouse

CAUTION

DAMAGE CAN BE CAUSED BY FALLING LIGHTHEAD

DANGER OF INJURY THROUGH INCORRECT FITTING OF THE LIGHTHEAD

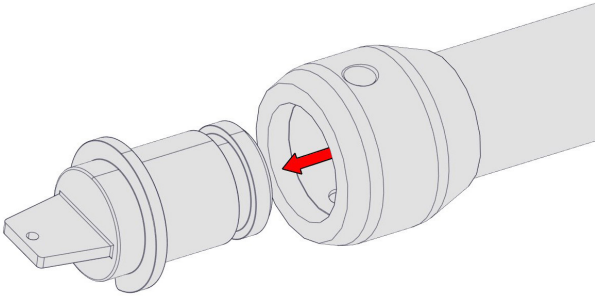
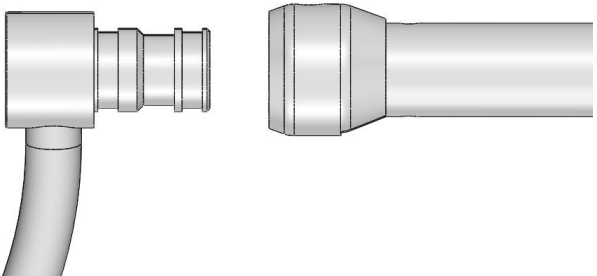
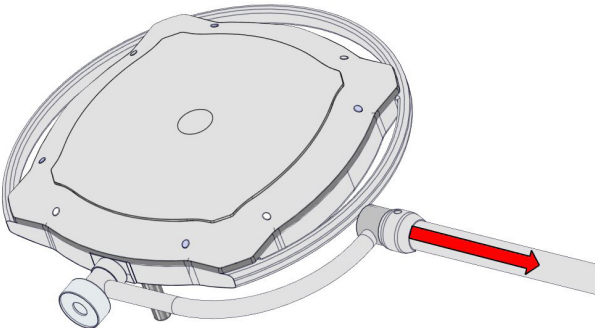
4.	Take out the plug from the arm. 
5.	Join the arm connector to the lighthouse connector. 
6.	Insert Lighthouse to the arm. 

Installing the Lighthouse

CAUTION

DAMAGE CAN BE CAUSED BY FALLING LIGHTHEAD

DANGER OF INJURY THROUGH INCORRECT FITTING OF THE LIGHTHEAD

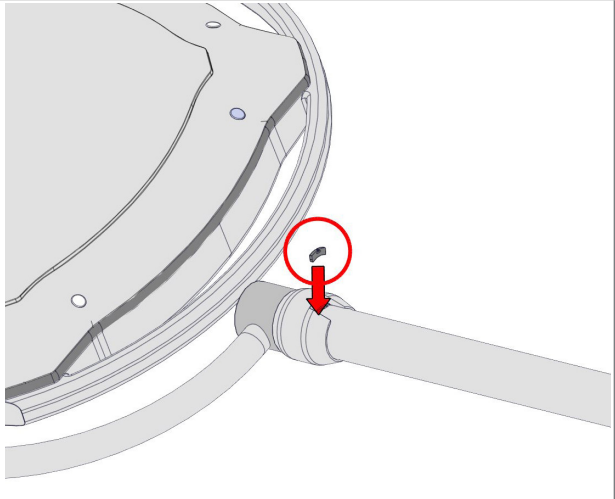
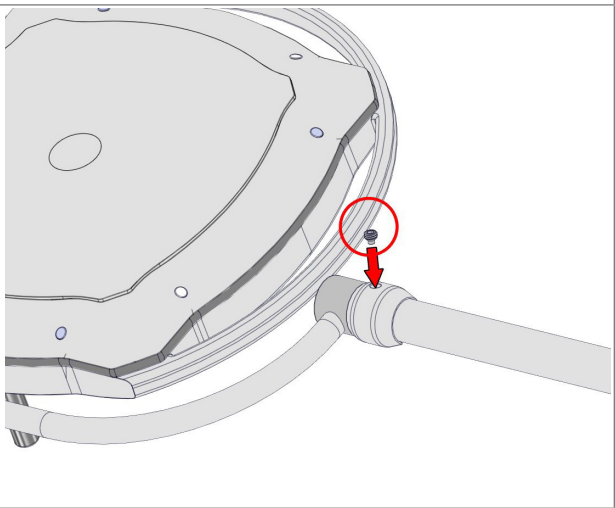
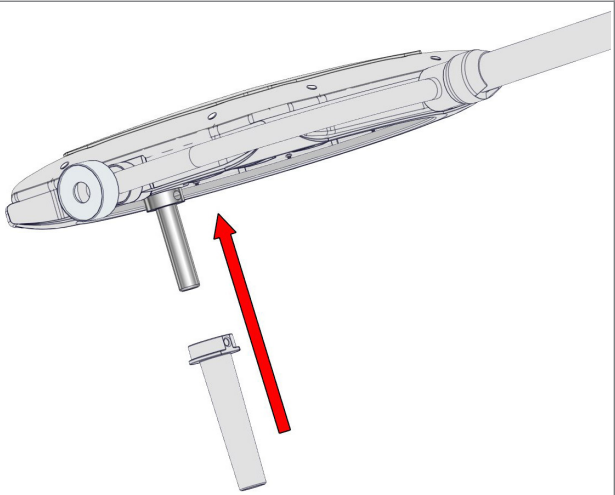
7.	Insert the safety segment back.	
8.	Turn back sleeve and tighten screw according to requirements of the friction from the Lighthouse.	
9.	Clip the handle on the Lighthouse.	

Operation

Mira LED - All Models

Switch on the Light from the control pad at Lighthouse.

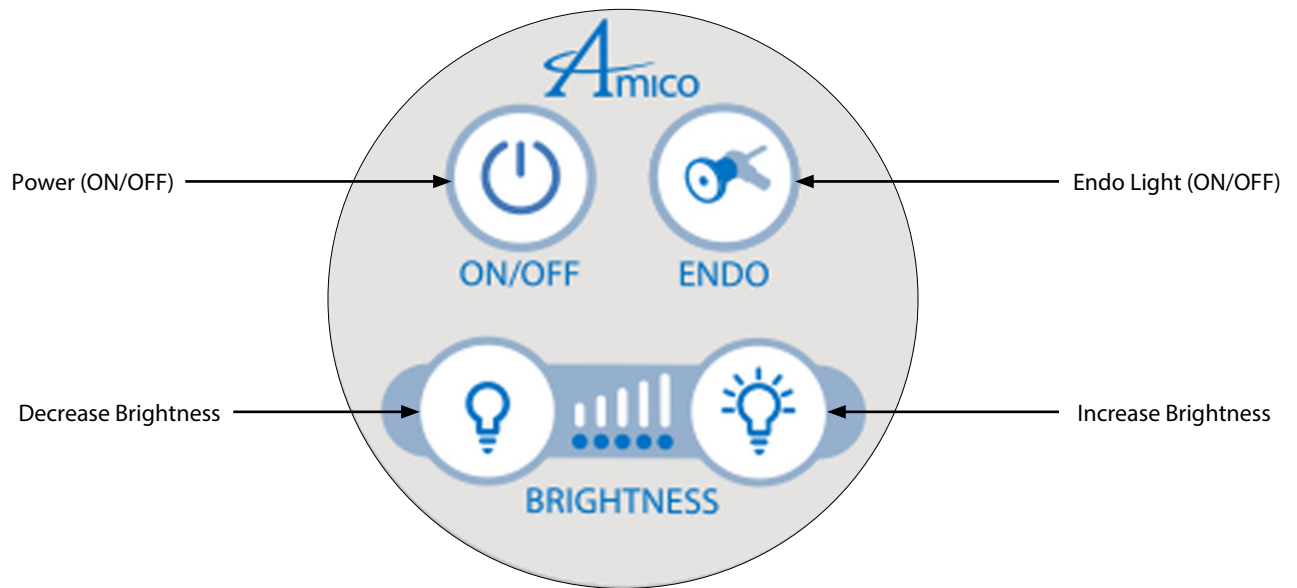

Disinfecting, Cleaning and Sterilization

NOTICE:

Damage due to improper cleaning.

- Do not use alcohol, solvent or cleaning agents containing chlorine or scouring agents.
- Damage to lens by concentrated disinfectant or solvent.
- Follow the manufacturers recommended mixing ratio.
- Use of incorrect cloths may scratch lens.

NOTICE:

A dirty lens will reduce the illuminating power.

- Clean lens regularly
- Spray and wipe disinfection is permitted.
- Clean the lens with a leather cloth soaked in cleaner
- Spray disinfectant in horizontal position

NOTICE:

The external components of the light can be disinfected with the following diluted products:

- Lysoformin
- Dismozon
- Hexaquart plus
- Sagrotan – fast disinfecting cleaner
- Tuffie5

NOTICE:

The local government regulations for disinfection must also be observed in addition to these instructions.

NOTICE:

Sterilize handle at 120°C and 1.05 bar for 30 minutes.

Maintenance

DANGER

ELECTRIC SHOCKS ARE LIFE-THREATENING

- Remove the connector from the power supply and put the switch in the "OFF" position.
- The connector cable must be checked for damage at least once per year

NOTES:

- Maintenance and repairs must only be carried out by qualified electricians.
- The corresponding user profile is described in Safety Instructions pages 5-6.

Setting the Spring Force

NOTE: The spring force is set at the optimum setting in the factory.

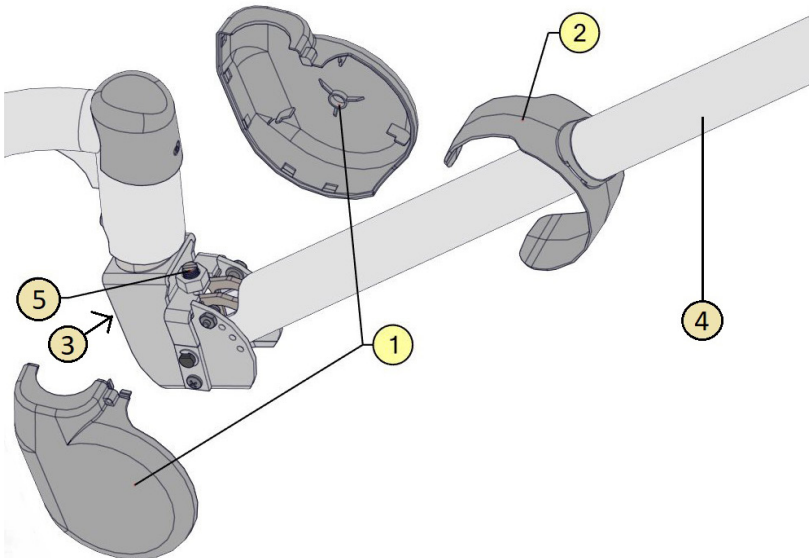

1. Uninstall the Elbow Caps by removing the screw securing it.
2. Slide the Elbow Cap cover to reveal the adjustment screw and push arm to upper position.
3. Loosen the screw from the other side for easy access as shown in the image.
4. The spring arm should be in the top most position before going to the next step.
5. Rotate the adjustment screw accordingly to set the spring force:
 - Turn screw counter clockwise (+) to increase spring force (when spring arm lowers)
 - Turn screw clockwise (-) to decrease spring force (when spring arm rises)

Notes on the Arm Systems

Selection of Fastening Material

We recommend the use of (not included in the delivery) counter-plates for fastening to drywall.

Cleaning and Disinfection

DANGER

ELECTRIC SHOCKS ARE LIFE-THREATENING

- The devices can conduct electricity and must be handled with care during cleaning and disinfection.
- If there is a power plug remove it from the socket.
- Do not use spraying methods for cleaning and/or disinfection.
- Do not spray liquid into the openings of electrical power sockets, gas sockets or devices, or allow liquid to enter these.

Recommended Cleaning Agents

Use mild soap solutions or standard detergents as cleaning agents. Wipe down the surfaces of the equipment with a dampened cloth. If necessary, use small quantities of mild soap solution as a cleaning agent. Then wipe the outer surfaces with a soft, clean cloth until they are completely dry.

Disinfection Procedure

Disinfection by wiping is intended to be the standard disinfection procedure for the support arm system. Hygiene guidelines and corresponding safety measures must be determined by the operator for the disinfection procedures that are applied.

- After the contamination by any potentially infectious material (such as blood, secretions or excrement), the areas must be disinfected immediately in a targeted way.
- Comply with application concentrations.
- Wipe the area to be disinfected rather than spraying it.
- Do not use areas that have been wiped until the disinfectant is dry.

Testing

DANGER

ELECTRIC SHOCKS ARE LIFE-THREATENING

During all testing work, disconnect the device from the power supply/remove the plug from the power socket and secure the device so that it cannot be switched on again.

Every 6 months or 5,000 Arm Movements, Check for:

- Paint damage
- Cracks in plastic parts
- Deformation of the support system
- Loosening of parts

Every 2 Years:

- The securing element of the cantilever arm must be checked and greased by a qualified professional

Notes on the Arm Systems

Disassembling for Servicing

DANGER

INJURY HAZARD

- The cantilever arm is under a high spring load. If the end device is not moved to the upper cantilever arm position, the cantilever arm will spring up, possibly causing serious injury. Only remove the end device if the cantilever arm is in the upper position.
- Disconnect the device from the power supply/remove the plug from the mains and ensure it cannot be switched on again.
- Place cantilever arm in the upper position.
- Unscrew the brake screw (1) so that the sleeve (2) can be turned.
- Turn the sleeve (2) through 180° until the securing segment (3) appears in the slot (4).
- Hold the end device head (5) firmly and remove the securing segment (3) using a narrow flat-bladed screwdriver.
- Remove end device (5) from the connection.
- Put protective cap in place.

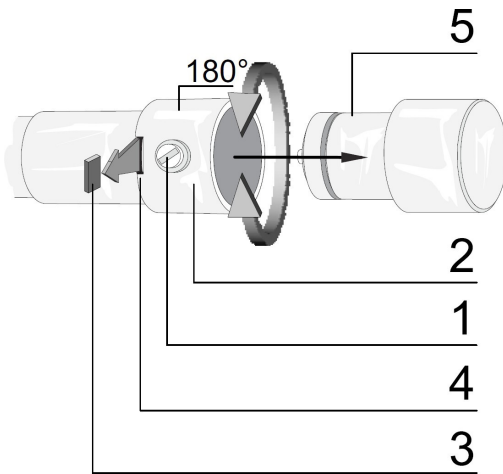

1. Brake screw
2. Sleeve
3. Securing segment
4. Slot
5. End device terminal

This system is designed to be equipped with end devices from other manufacturers. For end device operation instructions please refer to the operating instructions of the related manufacturer.

Spare Parts

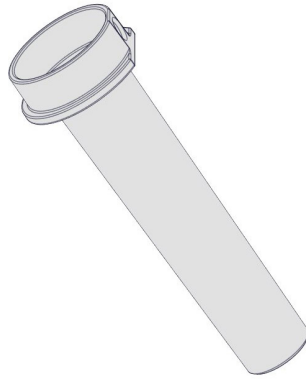

Handle (L-X-MILED-HDL-2)

Troubleshooting

Malfunction	Possible Cause	Remedy	User Profiles
Light does not come on	Contact fault	Switch on again	All
	Illuminant defective	Contact manufacturer's After-Sales Service	Only by manufacturer's After-Sales Service
	No mains power	Check power supply and all connections	Qualified electrician
	2A fuse defective (Mira LED Floor Stand only)	Replace fuse	Qualified electrician

Disassembling for Servicing

DANGER

ELECTRIC SHOCKS ARE LIFE-THREATENING

- Remove connector from the power supply and put the switch in the “OFF” position before disassembling.

DANGER

NEVER UNSCREW THE UPPER CABLE HOLDER - INJURY HAZARD

- When both cable holders are unscrewed, the connecting piece is loose and falls downward, which could cause injury and/or damage to the cable and/or the device.



Do not dispose of this product with normal refuse. Dispose of the product at a recycling center or return it to a dealer with a disposal service depending on local regulations. Cut off the cable flush with the housing.

Technical Data of the Lighthouse

	Units	Mira 50 LED	Mira 65 LED	Mira 90 LED
Lighthouse Diameter	in	18	18	18
Light Intensity (Central Luminance)	lx (fc)	50,000 Lux (4,762 fc) @ 1m (39.37")	65,000 Lux (6,190 fc) @ 1m (39.37")	90,000 Lux (8,571 fc) @ 1m (39.37")
Brightness Control	%	50-100	50-100	50-100
Light Field Diameter	in	6.5-12.0	6.5-12.0	6.5-12.0
Depth of Illumination	in	94.5	94.5	94.5
Color Rendering Index	Ra	95	95	95
R9	in	90	90	90
Color Temperature (Standard)	K	4500	4500	4500
Shadow Dilution				
Single Mask	%	0.7	0.7	0.7
Double Mask	%	55.5	55.5	55.5
Cavity	%	100	100	100
Single Mask with Cavity	%	0.3	0.3	0.3
Double Mask with Cavity	%	55.3	55.3	55.3
Number of LED's (Main)		36	36	36
LED Service Life	hours	70,000	70,000	70,000
Total Radiant Power at Maximum Intensity	W/m ²	178	231.4	317
Electrical		100-240 VAC, 50/60 Hz, 0.26 amps	100-240 VAC, 50/60 Hz, 0.31 amps	100-240 VAC, 50/60 Hz, 0.42 amps
Power Supply	ea	Direct Power Supply	Direct Power Supply	Direct Power Supply
Mounting Options		Ceiling, Wall, Floor Stand	Ceiling, Wall, Floor Stand	Ceiling, Wall, Floor Stand
Certificates		cETLus conform to UL60601-1; UL60601-2-41; UL certified IP54 per IEC 60598	cETLus conform to UL60601-1; UL60601-2-41; UL certified IP54 per IEC 60598	cETLus conform to UL60601-1; UL60601-2-41; UL certified IP54 per IEC 60598

Technical Data of the Arm System

Electrical	
Nominal Input Voltage	100-240 VAC
Frequency Range	50 / 60Hz
Input Current	4A-2A
Device Protection	Class 1 Approval ETL/cETL
Any power supply with output less than or equal to 60V, current output less than or equal to 5A and a minimum of two (2) MOOP can be used with the spring arm.	
Environmental Conditions for Transport, Storage, and Operation	
Storage and Transport After 15 weeks the conditions for operation apply.	-10°C to +50°C Ambient 20% to 90% humidity 700 hPa to 1060 hPa
Operation This product should be acclimatized to its operating conditions for 24 hours prior to its first use.	+10°C to +40°C 30% to 75% humidity
Weight	
Maximum Device Load	42Nm (375 in-lb)
Mira LED Wall Mount With Lighthead	9.0 kg (20.0 lbs)
Operating Mode	
Operating Mode	continuous operation
Classification	
Mira LED Swing	Class I
Classification under 93/42 EEC – Annex IX (medical device class)	Class I
Safety Testing According to:	CSA C22.2#60601-1 IEC/EN 60601-1 2nd. UL 60601-1

Warranty

Amico Lights Corporation warrants its products against defective materials and workmanship for twelve (12) months from the date of shipment. Within this period, Amico Lights Corporation will repair or replace any part on site or at the factory which is proven to be defective at Amico Lights Corporation's cost.

Furthermore, Amico Lights Corporation will warrant its material to be free from defect for an additional period of four (4) years (five [5] years from the date of shipment). Within this period, Amico Lights Corporation will replace any part at no charge, which is proven to be defective. Shipping and installation costs after the first twelve (12) months will be borne by the customer.

The spring arms for the above mentioned are warranted for a period of twelve (12) months. The warranty for the spring arms shall include parts and labor and shall commence from the date of shipment.

The warranty applies to normal usage and does not apply to any product that has been subject to alteration, abuse, negligence, or use (including voltage and/or current) other than that for which the product was designed.

Amico Lights Corporation shall not be liable for incidental or consequential damages resulting from the use of the equipment.

All claims for warranty must first be approved by Amico Lights Corporation. A valid Return Goods Authorization (RGA) number must be obtained from Amico Lights Corporation prior to commencement of any service work. Warranty work which has not been pre-authorized by Amico Lights Corporation will not be reimbursed.

www.amico.com

Amico Lights Corporation
122-B East Beaver Creek Road, Richmond Hill, ON L4B 1G6, Canada
Toll Free Phone: 1.877.462.6426 | Toll Free Fax: 1.866.440.4986
Tel: 905.764.0800 | Fax: 905.764.0862
Email: info@amico.com | www.amico.com

ALT-IM-MIRA-LED-LIGHT-WALL 12.06.2023

