

Installation and Maintenance Manual

Alarm Valve Combo Unit

Alert-1 v1.8



Contents

User Responsibility	4
Introduction	5
Features	5
Installation of Alarm Valve Combo Unit Boxes	6
Maintenance	7
Description of Modules: Common to All Alarms	8
System Power Supply	8
Annunciator Module	8
Alarm Valve Display Module	8
Sensor Module	8
Installation of Alarm	9
For Local Sensors Only	9
Standing Pressure Test	9
Frame/Module Assembly	9
Installation Guide	10
Sensor	10
Local	10
Remote	10
Wiring	11
System Power Supply	11
Annunciator Module	11
Sensor Module	11
Local	11
Remote	11
Annunciator Module	12
Noise Level Control	12
Steps to Re-Calibrate the Sensor Reading	12
Display Module - To Change High & Low Pressure Set Points	13-14
Factory Default - PSI	14
InchHg / kPa / BAR Selections	15
Factory Default - InchHg	15

Contents

Setting Gas Identification Switches	16
Chart of Gas Specific Settings of Dip-Switches	16
Troubleshooting Guide	17-18
Error Code Messages on the Display Module	19
Model Numbers	20
Alarm Vavle Combo Unit	20
Spare Part Numbers	21-22
Dimensions	23
Vertical Alarm Valve Combo Unit	23
Loca/Remote Sensor	23
Appendix A	24
Wiring Diagram: Auto-Switch Power Supply	
Appendix B	25
Wiring Diagram: Annunciator	
Appendix C	26
Wiring Diagram: Alarm Valve Combo Unit	
Appendix D	27
Wiring Diagram: Remote Alarm Valve Combo Unit	
Appendix E	28
Wiring Diagram: Alarm Valve Combo Unit to Master Module	
Appendix F	29
Technical Specifications	
Appendix G	30
Wiring	

User Responsibility

The information contained in this Installation and Operation Maintenance Manual pertains only to the Alarm Valve Combo Unit. This product will perform to conformity as described in this manual when assembled, operated, maintained and serviced in accordance with the installation instructions provided.

The Alarm Valve Combo Unit must be checked periodically. Parts that are broken, missing, worn, distorted or contaminated must be replaced immediately. Should such repair or replacement become necessary, please contact Amico Corporation or their distributors.

All alarms should not be repaired or altered without prior written or verbal approval of Amico Corporation or its distributors. Failure to comply will void all warranty on the alarm.

Statements in this manual preceded by the words WARNING, CAUTION, DANGER and NOTE are of special significance. Please read these sections carefully.

NOTE: Amico strongly recommends that Alarm Valve Combo alarms be check annually by a qualified staff.



WARNING: Denotes steps which can prevent injury.



CAUTION: Denotes steps which can prevent damage to equipment.



DANGER: Denotes steps which can prevent electrical shock to equipment or to prevent serious injury and/or death.

Introduction

The Alarm Valve Combo Unit is a 2-in-1 design, which combines the Area Alarm and Zone Valve Box, to compensate for space restrictions.

Amico Shutoff Valves are used to stop the flow of medical gas or vacuum in the medical gas distribution pipeline in cases of emergency or maintenance.

Valve Boxes must be installed to enclose the shutoff valves when the valves are located in areas accessible to unauthorized personnel.

The Amico medical gas Alarm Valve Combo Unit incorporates the latest microprocessor technology for alarm and surveillance systems. The alarm has been designed to provide user flexibility and reliability. This manual will enable the customer to install, use and maintain the alarm properly.

All gases or vacuum are displayed with large red LED's for clear visibility. To facilitate the monitoring function by hospital personnel, a trend bar is provided to show the direction of the gas/vacuum pressure. Under normal operation, the gas trend indicator will be in the GREEN - OK position. If the gas pressure approaches alarm condition, the trend indicator will display a RED - Caution indicator. If an alarm condition occurs, the buzzer will sound.

Features

- Individual microprocessor on each display and sensor module.
- Gas specific sensors can be mounted locally or remotely, up to 2,500 ft (750 m), utilizing #22 gauge stranded, shielded twisted pair cable ONLY
- The DISS gas specific sensor is housed in a solid tamper-proof enclosure. The Sensor Module is housed in an anodized aluminum and nickle-plated brass enclosure to act as a barrier against any interference.
- The Sensor Module is the smallest, computer-calibrated and temperature-compensated sensor in the industry.
- True digital LED display and trend indicator for each service monitored.
- Illuminated LED display that is visible at an angle or in dim lighting conditions.
- PSI, kPa or BAR display (switch selected).
- Self-diagnostic circuitry with error display for problem identification.
- Highly accurate solid state pressure piezoresistive transducer.
- Adjustable repeat alarm (1 to 60 minutes or off).
- Dry contacts for remote monitoring of High and Low alarm status.
- Modules are factory mounted on a hinged frame assembly for ease of installation and maintenance.
- Field programmable push buttons for adjustment of HI and LOW set-points on display module.
- Available in 1 to 7 display modules.
- Built-in relay for remote annunciator applications.

Installation of Alarm Valve Combo Unit Boxes

The Amico Valve Combo Unit is shipped in one container holding two separate packages. One package contains the Alarm Valve Combo. The other package contains the window and the frame assembly.

1. Recessed Valve Box: anchor the valve box rough-in to the studs so that the front edge will be flush or slightly recessed with the finished wall. The recommended mounting is 66" (1676 mm) from the top of the valve box to the finished floor.

NOTE: The Shutoff Valve handles should be installed to point downstream for pressurized gases.

2. Before brazing, remove all box plugs as they could melt during brazing. Wrap wet rags around the tube extensions next to the valves to prevent overheating and possible damage to the valve seals. Connect copper tubing to the valve extensions (outside the valve box) using brazing methods and materials in accordance with NFPA-99 or CSA Z7396.1-06. Once valve extensions are cool, remove rags.
3. Test the system (per appropriate standards) to ensure that the intended gas and vacuum services are connected to the appropriate lines.



WARNING: Misconnection of the gases could lead to serious or fatal injury to patients. Following the initial installation of shutoff valves, make certain that the intended services are correctly connected to the appropriate service lines.

4. Test the system for leaks (per appropriate standards).

NOTE: Pipe sealants should comply with the requirements of NFPA 99 or CSA Z7396.1-06. Use care to exclude pipe sealants from the valve cavity and from interior tube surfaces exposed to medical gas flow or vacuum service. Properly applied Teflon tape is an alternative to pipe sealants. Check Shutoff Valve handle operation for proper clearance from gauge (if installed).

5. After the wall is finished, remove the window by pulling the ring towards you and attach the aluminum frame to the alarm valve combo unit valve box with the No. 6 metal screws provided. Then put the window back in place.



Maintenance

Operate shutoff valves periodically and repair them, if seals tend to stick or leak. Notify all concerned personnel before shutting off any gas supply.



WARNING: To protect the lives of patients, always notify the appropriate medical facility staff before shutting off the supply of medical gas or vacuum through a shutoff valve. Do not close shutoff valves except in cases of emergency or maintenance.

Clean the exterior of the valve boxes routinely with soap and water. Strong solvents may damage the Lexan window.

Authorized hospital personnel should close shutoff valves in the event of fire, explosion or damage to the pipeline systems or equipment.

In Alarm Valve Combo Unit boxes, the Shutoff Valve handles become accessible after the window has been removed from the valve box.

To remove the window, grasp the ring and pull outwards. Turn valve handle towards you to shut off the flow of gas or vacuum.

Zone Valves have a swingout design body which makes changing the internal components of the ball valve easier.

All valve bodies can be accessed by loosening all bolts and nuts and removing only one bolt, at this point the valve body can be swung out for servicing.

For Annual Test

- **Reset power to make sure all LED's light up.**
- **Push and hold the "Test" button to light up all LED's and audible alarm.**

Description of Modules: Common to All Alarms

SYSTEM POWER SUPPLY

The System Power Supply has been pre-installed into the back box assembly. The System Power Supply converts the AC voltage supply to the alarm into two voltages: 5 VDC (regulated) required by the microprocessor hardware and 15 VDC (unregulated) required by the buzzer and the LED's. This unit also contains the main ON/OFF power switch, the transformer, the heat sink, the main fuse and fuse cover, the rectifying circuitry, the terminal blocks and the low voltage DC power cable for connecting this unit to the annunciator module. The System Power Supply can be easily removed and reinstalled by unscrewing it from the back box.

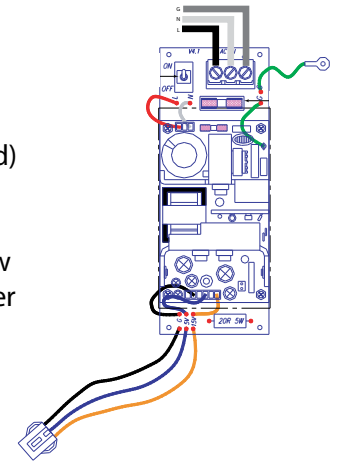

ANNUNCIATOR MODULE

The Annunciator Module contains the buzzer, a "Power On" LED as well as the "TEST" and "ALARM MUTE" buttons. The function of the "TEST" button is to verify that the buzzer and all the LED's are in working condition. An alarm will be heard when this button is pushed and all the LED's will light up. When the button is released, the alarm will silence. The "ALARM MUTE" button is used to silence an alarm that has occurred. This module also contains a fail-safe relay that de-energizes when the buzzer is activated. This relay can be used with the Amico remote buzzer, for applications requiring a remote audible alarm (see Appendix B), for connection to another Amico alarm or a building management system.

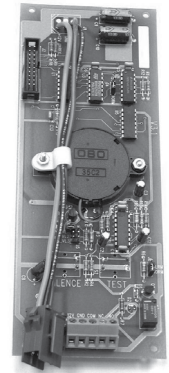

ALARM VALVE DISPLAY MODULE

The module provides a digital display of the actual pressure/vacuum of a gas being monitored. In addition, a gas trend indicator bar with High and Low alarms are displayed. The trend bar has two coloured LED's: GREEN for Normal and RED for High and Low conditions.

Each display module contains a gas specific, colour coded label (USA or ISO colours are available). The Display Module is field adjustable for pressure/vacuum settings, repeat alarm and unit of measure. Dry contacts for high and low alarms are available for remote monitoring of each module.



SENSOR MODULE

The Sensor Module contains the transducer which converts the gas/vacuum pressure source into a digital signal that is displayed on the display module. The sensor module shall be housed in an anodized aluminum and nickel-plated brass enclosure to act as an interference barrier. It is also temperature compensated.

Each sensor is clearly labeled and colour coded for the gas or vacuum being monitored. The sensor module contains a gas specific DISS fitting to ensure correct connection of the proper sensor to the respective gas. Each sensor has been factory calibrated by a computer for the specific gas shown on the sensor housing. If it is not connected to the appropriate gas display module, an error message (EO2) will be displayed.



Installation of Alarm

FOR LOCAL SENSOR ONLY

If the sensors are to be mounted locally (inside the valve box), the pipe stubs must be connected to the pipeline. Using silver-brazing techniques, connect each pipe stub to its appropriate gas or vacuum while ensuring that the bottom of the pipe stub is wrapped with a damp cloth. BE CAREFUL not to damage the DISS check-valve by overheating. When the brazing of pipe stubs has been completed, the system can be pressure tested.

STANDING PRESSURE TEST

Perform a standing pressure test on the piping system as per NFPA-99 "Health Care Facilities" or CSA-Z305.1 "Non-flammable Medical Gas Piping Systems". Inspect all joints for leaks and make certain each gas is piped to a correspondingly labeled gas service.

FRAME/MODULE ASSEMBLY

- Step #1 Remove the frame/valve window from its protective box
- Step #2 Attach the Sensor wire to the display module (Sensor +, -)
- Step #3 Close the valve window

Installation Guide



CAUTION: The microprocessor circuitry on the alarm valve unit contains sophisticated integrated semiconductors. If it becomes necessary to remove a module, PLEASE hold the boards by the edges. DO NOT TOUCH any of the components on the board. Static discharge can cause the modules to malfunction or become damaged.

SENSOR

LOCAL (Inside the Back Box)

- i. Locate the gas specific sensor module to be installed.
- ii. In the back box, there are colour coded gas labels located under the DISS Demand check valves. Each label identifies where each sensor module is to be placed.
- iii. The sensor module contains a gas specific DISS fitting. Push the sensor module hex-nut and nipple adapter up into the demand check-valve. With a wrench, tighten the nut so that it makes a good seal.

NOTE: Pressure on sensors is not to exceed 250 psi for pressure sensors and 30" for vacuum sensors. A failed or damaged filter may allow moisture or water in and damage the transducer.



The sensor can reach pressure up to:

Mid Pressure	0-99 Psi
Hi Pressure	0-249 Psi
Vacuum	0-30" Hg

REMOTE (Outside the Back Box)

- i. Connect a Tee (supplied by others) to the pipeline with a 1/4" NPT female connection that will accept the DISS Demand check-valve.
- ii. Locate the gas specific sensor module to be installed.
- iii. Thread the DISS Demand check-valve into the correct gas pipeline.
- iv. The sensor module contains a gas specific DISS fitting. Push the sensor module hex-nut and nipple adapter up into the demand check-valve. With a wrench, tighten the nut so that it makes a good seal.

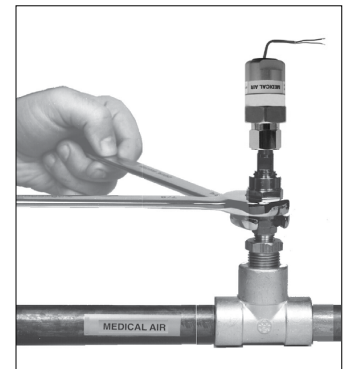

Wiring

SYSTEM POWER SUPPLY



CAUTION: TURN OFF THE POWER SWITCH before changing any modules and/or disconnecting any cables, or else the fuse will blow to protect the circuitry.

1. Ensure that the ON/OFF switch is in the OFF position.
2. Through the top left side of the back box, bring in the AC power wires. Knockouts are provided for making conduit connections to the box. All wiring is to be installed according to local and national codes.
3. Connect the AC power to the terminal blocks as shown in the wiring diagram in Appendix A and F.

ANNUNCIATOR MODULE

- i. The Annunciator Module has a female receptacle located at the top right side of the board (J1).
- ii. Connect the DC power cable from the System Power Supply into the receptacle connection located on the annunciator module. The connector is keyed and can only be plugged in one way, (Appendix B).

SENSOR MODULE

LOCAL (Inside the Back Box)

- i. The sensor module is provided with a 6"-8" (0.1 m-0.2 m) #22 gauge stranded, shielded twisted pair cable supplied. One wire is red (positive) and the other wire is black (negative). Connect the wires to the display module as shown in Appendix C. Take the red wire from the sensor and attach it to terminal "Sensor +" on the display module. Take the black wire from the sensor and attach it to terminal "Sensor -". The terminal block on the display module is clearly marked for proper connection of the sensor wires.
- ii. Repeat the above procedures with the remaining sensor modules.

REMOTE (Outside the Back Box)

- i. The sensor module is provided with a 6" - 8" (0.1 m - 0.2 m) #22 gauge stranded, shielded twisted pair cable supplied. Connect the wires to a junction box (not supplied) located near the sensor as per the wiring diagram in Appendix D.
- ii. Connect a shielded twisted pair cable from the junction box to the back box assembly. Knockouts are provided throughout the alarm back box. Up to 2,500 ft (750 m) of #22 gauge stranded, shielded twisted pair cable must be used.
- iii. Connect the red wire from the cable to the terminal on the display module marked "Sensor +". Connect the black wire to terminal "Sensor -" (see Appendix D).
- iv. Repeat the above procedures with the remaining sensor modules using the wiring diagram in Appendix D.

NOTE: When remote sensors are used, a #22 gauge stranded, shielded twisted pair cable is required (BELDEN #8451 or equivalent, supplied by others). Ensure that the proper gas sensor module is connected to its corresponding area display module, otherwise an error message (E02) will be displayed on the Display module.

Annunciator Module

NOISE LEVEL CONTROL

Factory Default: 80 Decibels

To decrease noise level:

Locate jumper at J5. Move jumper to:

LVL1	=	90 dBa.
LVL2	=	80 dBa.
LVL3	=	70 dBa.

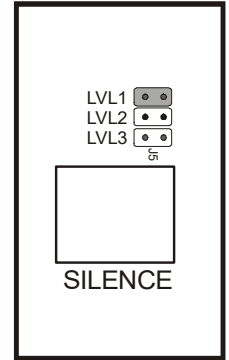

Control of Remote Alarm Buzzer

Factory Default: Normal Condition

To silence remote alarm buzzer when silencing the annunciator module:

Locate jumper at J6. Move jumper to:

NORM	=	Remote alarm buzzer will silence when annunciator module is silenced.
ALRM	=	Remote alarm will not silence when annunciator module is silenced. The buzzer will only silence when an alarm condition has been cleared. Please refer to Appendix B.

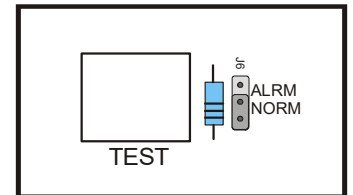

Steps to Re-Calibrate the Sensor Reading

1. Turn on Alarm.
2. Set switches #8 and #10 the OFF position.
3. Set switches #5 and #6 the ON position.
4. The display will show the current reading of the pressure.
5. Adjust the calibration, using the "UP" and "DOWN" push buttons, to the desired value.
6. Set switches #5 and #6 the OFF position.
7. Turn on #10 if AIMS is connected (do not turn on #8).

When you have completed step #7, the display module will automatically go into "RESET" mode. This will store the data that you entered.

Display Module - To Change High & Low Pressure Set Points

A dip-switch is located on the back of the display module which is used to identify the gas of the display module. The dip-switch contains ten switch settings.

PRESSURE ONLY

Factory Default:

High = 60 psi
 Low = 40 psi
 Repeat time = 30 min.

HIGH PRESSURE/NITROGEN

Factory Default:

High = 195 psi
 Low = 140 psi
 Repeat time = 30 min.

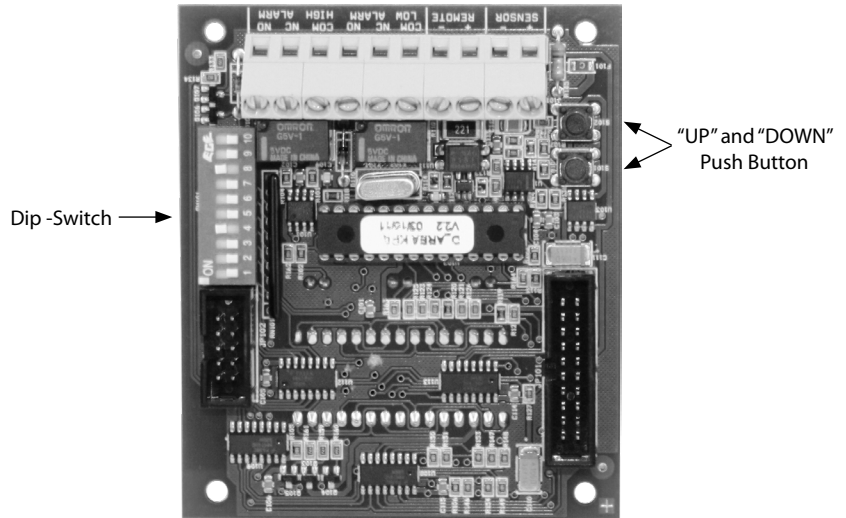

Compact Alarm Board

During programming, the "Trend Bar" will flash!

1. Set switch #6, #7 and #8 to the ON position.
2. The LED will display (HI-), followed by the current set point. Indicating that the system is ready to accept a new High set point. Adjust set point, using the "UP" and "DOWN" push buttons, to the desired value.
3. Set switch #7 to the OFF position.
4. The LED will display (LO-), followed by the current set point. Indicating the system is ready to accept a new Low set point. Adjust set point, using the "UP" and "DOWN" push buttons, to the desired value.
5. Set switch #8 to the OFF position.
6. The LED will display (I-I), followed by the current set point. Indicating the system is ready to accept a new Repeat Time set point. Adjust set point using the "UP" and "DOWN" push buttons, to the desired value. [(Display dd=Disabled) Range from 1 to 60 Minutes]
7. Set switch #6 to the OFF position.

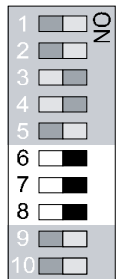

When you have completed step #7, the display module will automatically go into "RESET" mode. This will store the data that you entered.

Display Module - To Change High & Low Pressure Set Points

FACTORY DEFAULT - PSI

For PSI mode, set the switch #4 to the ON position. The LED PSI indicator located next to the gas pressure reading will illuminate.

For kPa mode, set the switch #4 to the OFF position and switch #9 to the ON position. The LED kPa indicator located next to the gas pressure reading will illuminate.

For BAR set the switch #4 to the OFF and the switch #9 to the OFF position. The LED kPa indicator located next to the gas pressure reading will illuminate. (There is no separate indicator for BAR).

VACUUM ONLY

Vacuum alarm set-point adjustment.

Factory Default:

High	=	30" Hg
Low	=	12" Hg
Repeat time	=	30 min.

During programming, the "Trend Bar" will flash!

1. Set switch #6, #7 and #8 to the ON position.
2. The LED will display (HI-), followed by the current set point. Indicating the system is ready to accept a new High set point. Do not adjust this set point since the High set point is not used.
3. Set switch #7 to the OFF position.
4. The LED will display (LO-), followed by the current set point. Indicating the system is ready to accept a new Low set point. Adjust set point, using the "UP" and "DOWN" push buttons, to the desired value.
5. Set switch #8 to the OFF position.
6. The LED will display (I-I), followed by the current set point. Indicating the system is ready to accept a new Repeat Time set point. Adjust set point using the "UP" and "DOWN" push buttons, to the desired value. [(Display dd=Disabled) Range from 1 to 60 Minutes].
7. Set switch #6 to the OFF position.

When you have completed step #7, the display module will automatically go into "RESET" mode. This will store the data that you entered.

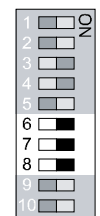
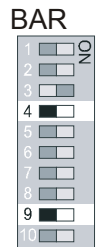
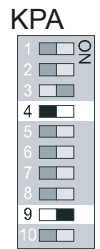
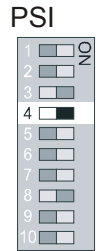

InchHg / kPa / BAR Selections

FACTORY DEFAULT - InchHg

For InchHg mode, set the switch #4 to the ON position. The LED indicating InHg located next to the vacuum source reading will illuminate.

For kPa mode, set the switch #4 to the OFF position and the switch #9 to the ON position. The LED indicating kPa located next to the vacuum source reading will illuminate.

For BAR mode, the kPa indicating source must be changed to BAR by use of a label. Set the switch #4 to the OFF and the switch #9 to the OFF position. The LED indicating BAR located next to the vacuum source reading will illuminate.

COMMON SETTINGS FOR PRESSURE AND VACUUM

Repeat Alarm Enable/Disable

Factory Default - Disable

Disable

Set switch #5 to the OFF position to disable the repeat alarm.

NOTE: When the repeat alarm function is disabled, the alarm will not repeat.

Enable

Enable Mode: (Factory Default 30 min, when enabled).

Set switch #5 to the ON position.

PLEASE NOTE: The module with the lowest set Repeat Time is the one that controls the Repeat Time. For example, if one module is set for 5 minutes and one for 30 minutes and both are Repeat Alarm enabled, the alarm will now repeat every 5 minutes.

SETTING FACTORY DEFAULT

To quickly reset the module (Pressure or Vacuum) to the factory default settings as follows:

- Pressure: High set-point 60 Psi, Low set-point 40 Psi.
- Nitrogen and HP Air: High set-point 195 Psi, Low set-point 140 Psi.
- Vacuum: Low set-point 12 inchHg.
- No Repeat alarm, but set for 30 min.

1. Set switch #8 to the ON position.
2. Turn the power off (wait 5 seconds) then back on.
3. Set switch #8 to the OFF position.

The module is now in the default mode.

InchHg

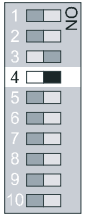

KPA

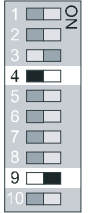

BAR

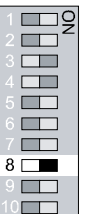
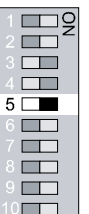
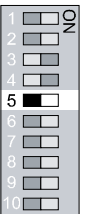
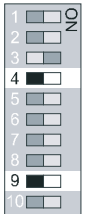

Setting Gas Identification Switches

NOTE: DO NOT tamper with switches #1, 2 and 3 on the dip-switch. Tampering with these positions will result in an error message being displayed (E02) and will disable the electrical interlock from the gas specific sensor.



WARNING: Changes to these switches should only be done by properly trained personnel, when circuit boards have to be changed in the field.

Switches #1, #2 and #3 are used for the gas identification of the display module. These will be set at the factory and should not be tampered with in the field.

Chart of Gas Specific Settings of Dip-Switches

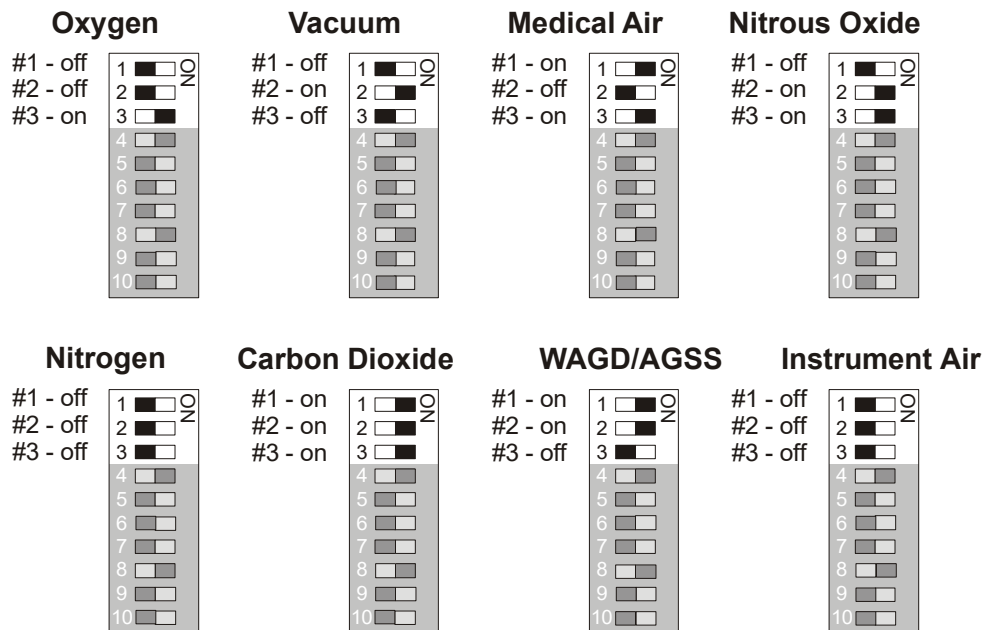

Troubleshooting Guide

Symptom	Cause	Corrective Action
An error code appears on one or more display modules.	The microprocessor detected a fault and has shut down.	Turn power switch to OFF position. Wait for at least 5 seconds before turning on the power. The program will reset itself.
	Faulty wire connection between the sensor and display module.	Check error codes at the end of this section.
No power on the alarm (no LED's illuminated).	AC power not available.	<ol style="list-style-type: none"> 1. Ensure that the ON/OFF switch on the power supply module is turned ON. 2. AC wiring not connected. 3. Check the building electrical breaker to ensure that the power is ON. 4. Check the voltage at the terminal block above the transformer. Ensure that 115 VAC or 220 VAC is being supplied.
	Fuse is blown.	Check the fuse. The fuse is located on the upper right corner of the system power supply. Replace the fuse if it is defective. See Appendix A and F.
	DC power plug not connected to the annunciator module.	<ol style="list-style-type: none"> 1. Ensure that the DC power plug is firmly in its socket on the annunciator module. 2. Replace System Power Supply unit if all the above steps fail to resolve the problem.
	Defective ribbon cable.	Replace the ribbon cable.
Power light on the annunciator module is ON but LED's on other modules are not on.	DC power cable is not connected to the annunciator module.	<ol style="list-style-type: none"> 1. Ensure that the DC power cable is firmly in its socket on the annunciator module. 2. Ensure that the module(s) on the Frame/Module assembly are all connected to the ribbon-cable. 3. Replace the annunciator module.
No audible alarm and LED's are not illuminating.	DC power cable is disconnected or loose.	<ol style="list-style-type: none"> 1. Ensure that the DC power cable from the system power supply is connected to the annunciator module snugly. 2. Depress "TEST" button. If the LED's come on and there is no audible alarm, replace the annunciator module. If this does not work, try solutions to problem #2.

Troubleshooting Guide

Symptom	Cause	Corrective Action																
Audible signal will not silence.	Faulty display module.	Disconnect the ribbon cable from the back of the faulty display module(s) and replace the module(s).																
	Connection of the DC power cable from system power supply to annunciator module is loose.	Disconnect the DC power cable from the annunciator module and then reconnect. If the audible signal still persists, replace the System Power Supply unit.																
	Faulty annunciator module.	Replace annunciator module.																
Alarm condition exists but LED's are not illuminating.	Display module not properly calibrated.	<ol style="list-style-type: none"> Ensure that the system was properly ordered. Factory default settings: <table border="0"> <tr> <td>Mid Pressure:</td> <td></td> </tr> <tr> <td> Hi Pressure</td> <td>60 Psi</td> </tr> <tr> <td> Low Pressure</td> <td>40 Psi</td> </tr> <tr> <td>Vacuum:</td> <td></td> </tr> <tr> <td> Low Vacuum</td> <td>12 inHg</td> </tr> <tr> <td>High Pressure:</td> <td></td> </tr> <tr> <td> Hi: Nitrogen & Air</td> <td>195 Psi</td> </tr> <tr> <td> Low: Nitrogen & Air</td> <td>140 Psi</td> </tr> </table> If calibration is required, refer to setting HIGH and LOW calibration procedure on page 13-14. 	Mid Pressure:		Hi Pressure	60 Psi	Low Pressure	40 Psi	Vacuum:		Low Vacuum	12 inHg	High Pressure:		Hi: Nitrogen & Air	195 Psi	Low: Nitrogen & Air	140 Psi
	Mid Pressure:																	
Hi Pressure	60 Psi																	
Low Pressure	40 Psi																	
Vacuum:																		
Low Vacuum	12 inHg																	
High Pressure:																		
Hi: Nitrogen & Air	195 Psi																	
Low: Nitrogen & Air	140 Psi																	
Faulty display module.	Replace the display module.																	
Gas reading incorrect.	Loose connection of DISS fittings.	Ensure that the sensor module is properly connected to the DISS demand check-valve																
	Sensor module is not properly wired to the display module.	Ensure that the sensor module is properly wired to the display module by using wiring diagram in Appendix C or D.																
	Defective sensor or requires calibration.	Replace the sensor module.																
	The ribbon cable is not properly connected to the display module.	Pull out the ribbon cable and connect it back in again, while ensuring that it is seated properly																
	Defective display module.	Replace the display module.																

Error Code Messages on the Display Module

System	Cause	Corrective Action	Page
E00 or E01	No sensor is connected or wires are not connected properly on terminals.	Connect a sensor and check the wiring.	26/27
E02	Sensor and Display Module mismatched.	Ensure that the Sensor and Display Module are for the same gas.	16
E03	The High set-point was set below the Low set-point or vice versa.	Recalibrate the High and Low setpoint to proper values.	13/14
E04	Incorrect type of Sensor connected (e.g. 250 psi sensor on a 100 psi range).	Connect the correct Sensor to the matching Display Module.	
E06	Cable between the sensor and display module shorted out or reversed polarity.	Reverse polarity or replace cable if defective.	26/27
E07	Out of calibration / Sensor not reading gas.	Replace the sensor module.	26/27

NOTE: Any of other error codes, contact Amico technical support to isolate the issue

Model Numbers

Alarm Valve Combo Unit

AVL-XGXGXGXGXGXGXG

The Letter "L" Defines the Language:

English (NFPA)	=	U
Spanish (NFPA)	=	S
Spanish (CSA/ISO)	=	H
English (CSA/ISO)	=	E
French (CSA/ISO)	=	F

The Letter "X" Defines the Valve Size:

1/2" [1.3 cm]	05	=	1
3/4" [1.9 cm]	07	=	2
1" [2.5 cm]	10	=	3
1-1/4" [3.2 cm]	12	=	4
1-1/2" [3.8 cm]	15	=	5
2" Full Port [5.1 cm]	20F	=	6

The Letter "G" Defines the Type of Gas:

Oxygen	=	O
Medical Air	=	A
MedVac	=	V
Nitrous Oxide	=	2
Nitrogen	=	N
Carbon Dioxide	=	C
WAGD (NFPA)	=	W
AGSS (ISO)	=	E
Instrument Air	=	I

NOTES:

- The power supply requires 1 gang per box.
Example: English, 3 valves, 1/2" Oxygen, 3/4" Medical Air and 1-1/4" Medical Vacuum. Will be in a 4 gang box, not a 3 gang: **AVU-1O2A4V**
- The 1-1/2" valve will have an empty space above the valve.
Example: a box with a 1/2" Oxygen, 3/4" Medical Air and 1-1/2" Medical Vacuum and a power supply will require a 5 gang box not a 4 gang box.
- The 2" valve will be assembled in a 6-1/2" deep box and shall accommodate up to a maximum of four gases. The 2" valve shall be positioned on the bottom of the assembly. The height measurements of the 6-1/2" deep valve box are the same as the 3-7/8" deep valve box. When comparing height measurements, consider the gap above the 2" valve.
Example: a valve box with 1/2" valve, 2" valve and a power supply would be in a 3 gang, 6-1/2" deep box, which would be the same height as the 4 gang, 3-7/8" valve box.
- 2-1/2" and 3" valve assemblies are only offered as singles.

Spare Parts Numbers

Model Number	Description
A2P-ANNU-AVC	AVC ANNUNCIATOR C.B ASSY GRAY CAP
A2P-POWER-V2	POWER SUPPLY MODULE ALERT-2
A2P-SENS-E-AIR	SENSOR MODULE ISO-AIR ENG. ALERT-2
A2P-SENS-E-CO2	SENSOR MODULE ISO-CO2 ENG. ALERT-2
A2P-SENS-E-EVA	SENSOR MODULE ISO-EVA ENG. ALERT-2
A2P-SENS-E-N2O	SENSOR MODULE ISO-N2O ENG. ALERT-2
A2P-SENS-E-NIT	SENSOR MODULE ISO-NIT ENG. ALERT-2
A2P-SENS-E-OXY	SENSOR MODULE ISO-OXY ENG. ALERT-2
A2P-SENS-E-VAC	SENSOR MODULE ISO-VAC ENG. ALERT-2
A2P-SENS-U-AIR	SENSOR MODULE USA-AIR ENG. ALERT-2
A2P-SENS-U-OXY	SENSOR MODULE USA-OXY ENG. ALERT-2
A2P-SENS-U-VAC	SENSOR MODULE USA-VAC ENG. ALERT-2
A2P-SENS-U-WAG	SENSOR MODULE USA-WAG ENG. ALERT-2
A2P-SENS-U-IAR	SENSOR MODULE USA-INSTRUMENT AIR ALERT-2
A2P-COMPAC-CB	AVC DISPLAY MODULE FOR ALL GAS V202
A2P-AVCDIS-E-AIR	ALARM VALVE COMBO DIS. MODU ISO-AIR ENG.
A2P-AVCDIS-E-OXY	ALARM VALVE COMBO DIS. MODU ISO-OXY ENG.
A2P-AVCDIS-E-VAC	ALARM VALVE COMBO DIS. MODU ISO-VAC ENG.
A2P-AVCDIS-E-NIT	ALARM VALVE COMBO DIS. MODU ISO-NIT ENG.
A2P-AVCDIS-E-N2O	ALARM VALVE COMBO DIS. MODU ISO-N2O ENG.
A2P-AVCDIS-E-CO2	ALARM VALVE COMBO DIS. MODU ISO-CO2 ENG.
A2P-AVCDIS-E-AGS	ALARM VALVE COMBO DIS. MODU ISO-AGS ENG.
A2P-AVCDIS-U-OXY	ALARM VALVE COMBO DIS. MODU USA-OXY ENG.
A2P-AVCDIS-U-AIR	ALARM VALVE COMBO DIS. MODU USA-AIR ENG.
A2P-AVCDIS-U-VAC	ALARM VALVE COMBO DIS. MODU USA-VAC ENG.
A2P-AVCDIS-U-WAG	ALARM VALVE COMBO DIS. MODU USA-WAG ENG.
A2P-AVC-MYLA-E-O	ALARM VALVE COMBO MYLAR ENG. OXY ISO
A2P-AVC-MYLA-E-A	ALARM VALVE COMBO MYLAR ENG. AIR ISO
A2P-AVC-MYLA-E-V	ALARM VALVE COMBO MYLAR ENG. VAC ISO
A2P-AVC-MYLA-E-N	ALARM VALVE COMBO MYLAR ENG. NIT ISO
A2P-AVC-MYLA-E-2	ALARM VALVE COMBO MYLAR ENG. N2O ISO
A2P-AVC-MYLA-E-C	ALARM VALVE COMBO MYLAR ENG. CO2 ISO
A2P-AVC-MYLA-E-E	ALARM VALVE COMBO MYLAR ENG. AGS ISO
A2P-AVC-MYLA-U-O	ALARM VALVE COMBO MYLAR ENG. OXY NFPA
A2P-AVC-MYLA-U-V	ALARM VALVE COMBO MYLAR ENG. VAC NFPA
A2P-AVC-MYLA-U-A	ALARM VALVE COMBO MYLAR ENG. AIR NFPA
A2P-AVC-MYLA-U-W	ALARM VALVE COMBO MYLAR ENG. WAG NFPA
A2X-AVC-RIBBON2	2 STN RIB CABLE FOR ALRM/VALVE COMBO
A2X-AVC-RIBBON3	3 STN RIB CABLE FOR ALRM/VALVE COMBO
A2X-AVC-RIBBON4	4 STN RIB CABLE FOR ALRM/VALVE COMBO

Spare Parts Numbers

Model Number	Description
A2X-AVC-RIBBON5	5 STN RIB CABLE FOR ALRM/VALVE COMBO
A2X-AVC-RIBBON6	6 STN RIB CABLE FOR ALRM/VALVE COMBO
A2X-AVC-RIBBON7	7 STN RIB CABLE FOR ALRM/VALVE COMBO
A2X-AVC-DVPLATE-P	DIVIDER PLATE FOR 1GAS ALARM VALVE COMBO
A2X-AVC-DVPLAT2-P	DIVIDER PLATE FOR 2GAS ALARM VALVE COMBO
A2X-AVC-DVPLAT3-P	DIVIDER PLATE FOR 3GAS ALARM VALVE COMBO
A2X-AVC-DVPLAT4-P	DIVIDER PLATE FOR 4GAS ALARM VALVE COMBO
A2X-AVC-DVPLAT5-P	DIVIDER PLATE FOR 5GAS ALARM VALVE COMBO
A2X-AVC-DVPLAT6-P	DIVIDER PLATE FOR 6GAS ALARM VALVE COMBO
A2X-AVC-BRKT-2F	P/S COVER FOR ALARM VALVE COMBO
A2X-AVC-PLT-02N	DIVIDER PLATE FOR ALARM VALVE COMBO
A2X-P-SW-AVCCAP	ALARM VALVE COMBO KEYCAP - GRAY
S-DIS-KIT-OXY	DISS DEMAND CHECK, NUT & NIPPLE – OXY
S-DIS-KIT-AIR	DISS DEMAND CHECK, NUT & NIPPLE – AIR
S-DIS-KIT-VAC	DISS DEMAND CHECK, NUT & NIPPLE – VAC
S-DIS-KIT-N2O	DISS DEMAND CHECK, NUT & NIPPLE – N2O
S-DIS-KIT-NIT	DISS DEMAND CHECK, NUT & NIPPLE – NIT
S-DIS-KIT-CO2	DISS DEMAND CHECK, NUT & NIPPLE – CO2
S-DIS-KIT-EVA	DISS DEMAND CHECK, NUT & NIPPLE – EVA
S-DIS-DEMC-AIR	DISS DEMAND CHECK VALVE 1/4"MNPT - AIR
S-DIS-DEMC-OXY	DISS DEMAND CHECK VALVE 1/4"MNPT - OXY
S-DIS-DEMC-VAC	DISS DEMAND CHECK VALVE 1/4"MNPT - VAC
S-DIS-DEMC-N2O	DISS DEMAND CHECK VALVE 1/4"MNPT – N2O
S-DIS-DEMC-NIT	DISS DEMAND CHECK VALVE 1/4"MNPT - NIT
S-DIS-DEMC-CO2	DISS DEMAND CHECK VALVE 1/4"MNPT – CO2
S-DIS-DEMC-EVA	DISS DEMAND CHECK VALVE 1/4"MNPT - EVA
A2P-SENS-E-IAR	SENSOR MODULE ISO-INSTRUMENT AIR
A2P-AVCDIS-U-IAR	AVC DIS.MODU USA-INSTRUMENT-AIR ENG.
A2P-AVCDIS-E-IAR	AVC DIS.MODY ISO-INSTRUMENT IAR ENG.
A2P-AVC-MYLA-U-IAR	ALARM VALVE COMBO MYLAR INST AIR US
A2P-AVC-MYLA-E-IAR	ALARM VALVE COMBO MYLAR INST AIR ISO
S-DIS-KIT-IAR	DISS CHECK, NUT & NIPPLE -INSTAIR
S-DIS-DEMC-IAR	DISS DEMAND CHK INST.AIR X 1/4" MNPT

Dimensions

Vertical Alarm Valve Combo Unit

Inch
[mm]

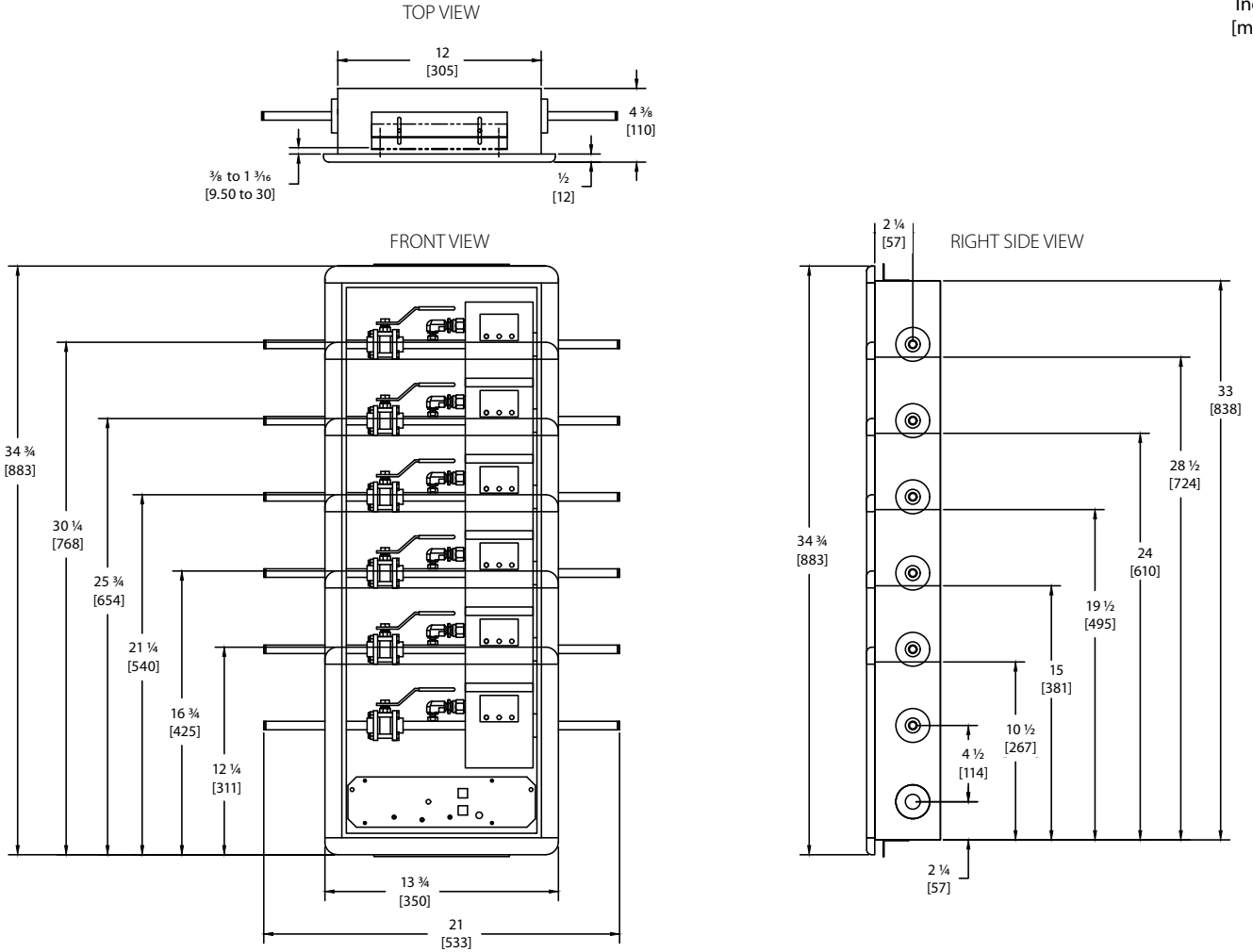

Loca/Remote Sensor

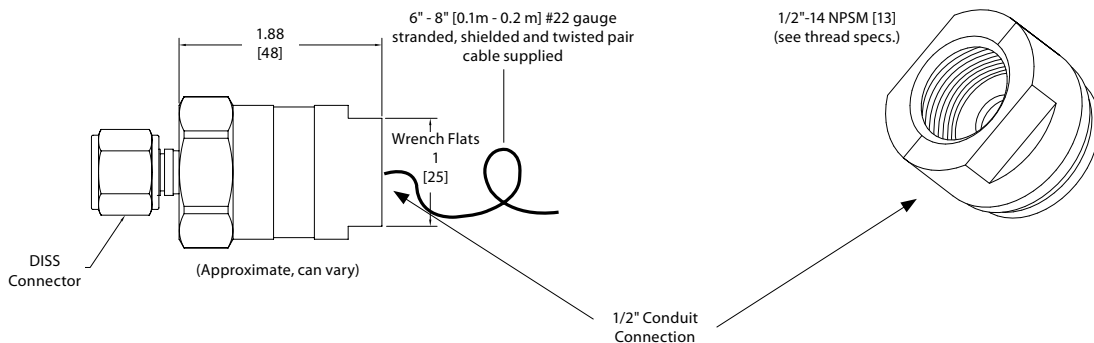

NOTE: DISS Demand check valves by 1/4" NPT, supplied with each remote sensor.

Appendix A

WIRING DIAGRAM: AUTO-SWITCH POWER SUPPLY

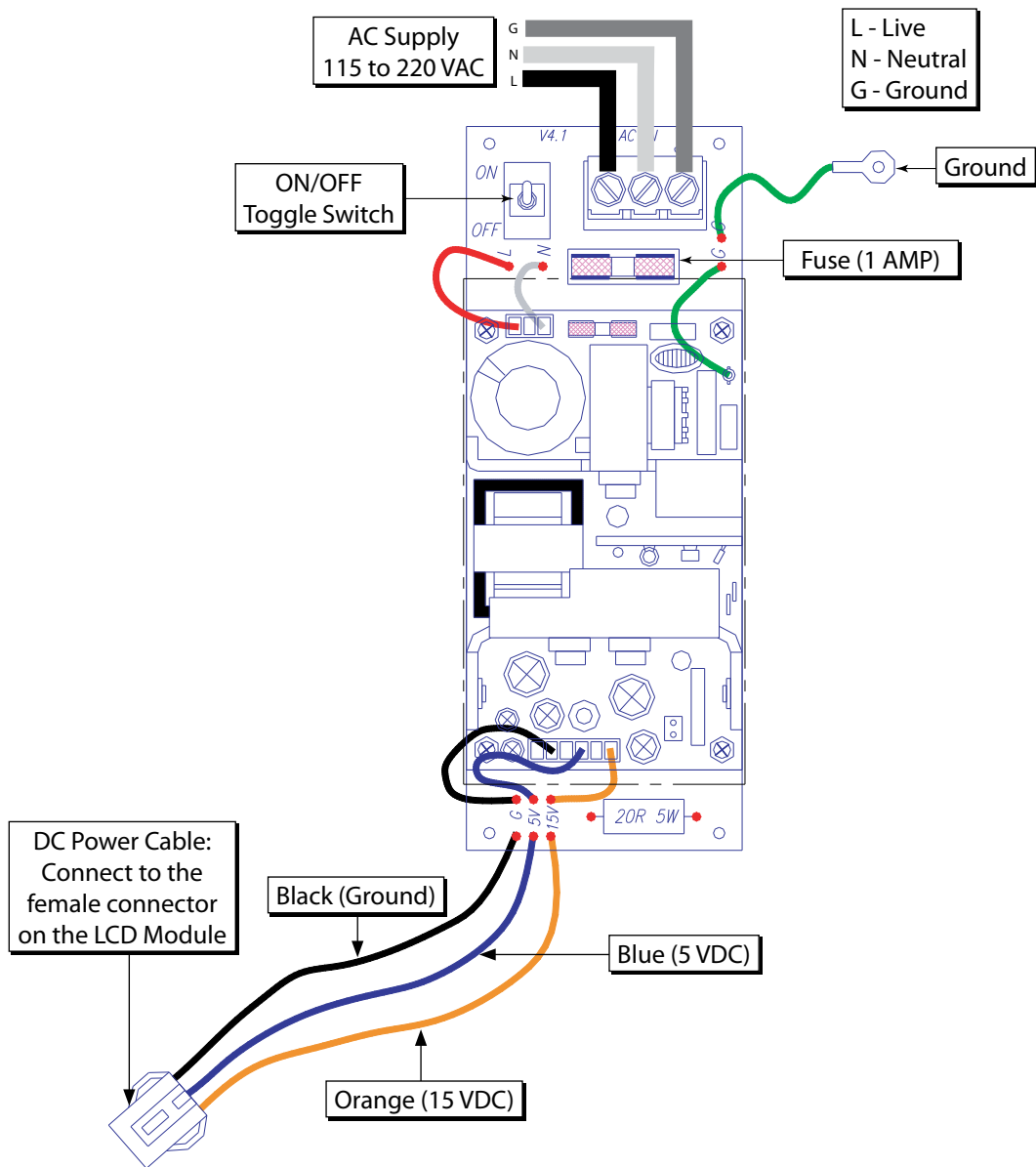

CAUTION:

1. Verify that power has been switched off prior to working on the alarm
2. Risk of electric shock, disconnect power at the circuit breaker before removing power supply shield

Appendix B

WIRING DIAGRAM: ANNUNCIATOR

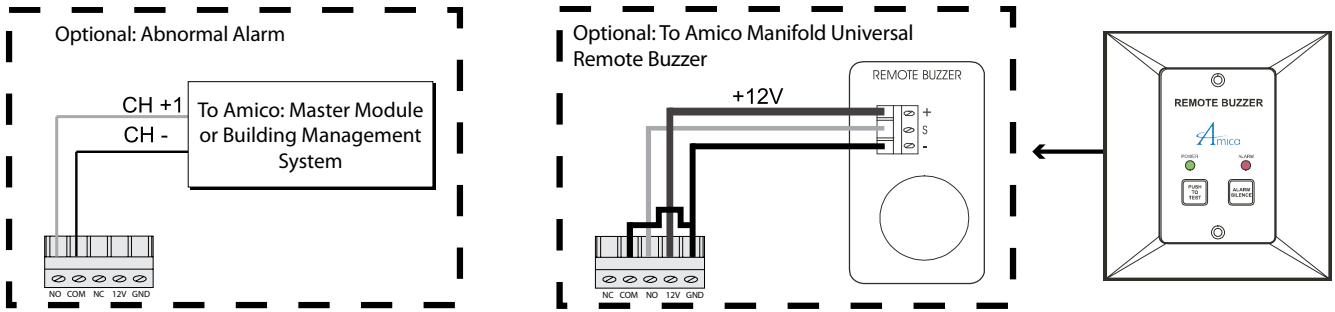

NOTE: Amico recommends max. 50 ft. to power up buzzer from any Amico devices (alarm/manifold). More than 50 ft., a A3P-Power-V4 is required to supply voltage for the manifold buzzer.

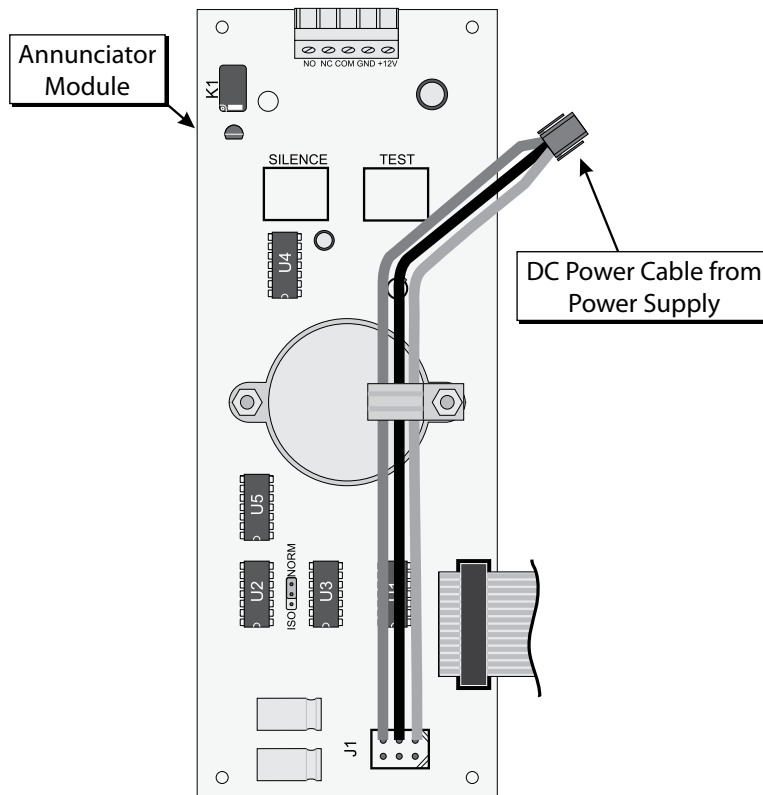

Appendix C

WIRING DIAGRAM: ALARM VALVE COMBO UNIT

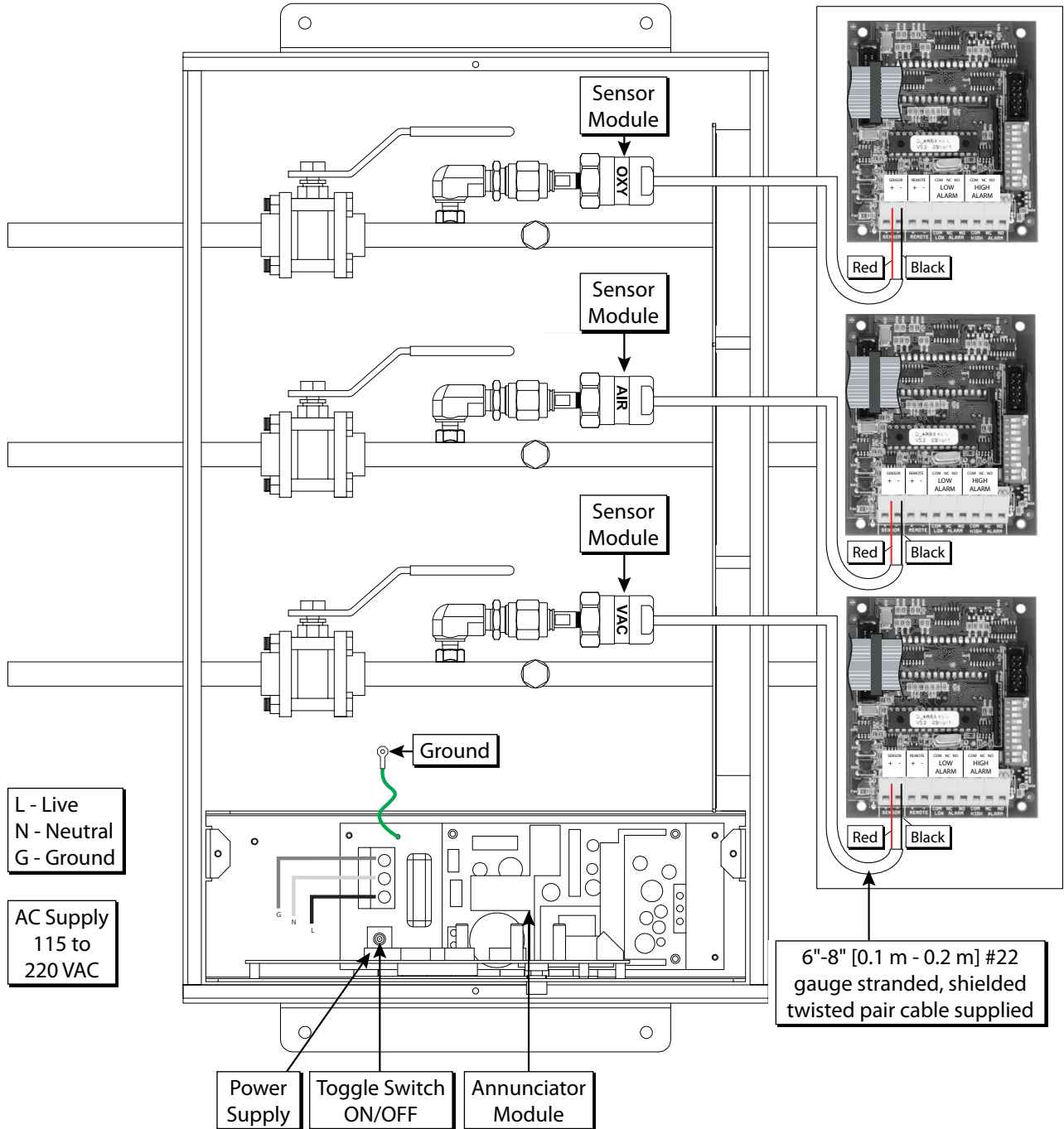

NOTE:

1. Do not ground the shield drain wire at sensor or inside the alarm panel back box.
2. To protect from static electricity, ensure to discharge body static before installing the Medical Gas Alarm and sensors.

Appendix D

WIRING DIAGRAM: REMOTE ALARM VALVE COMBO UNIT

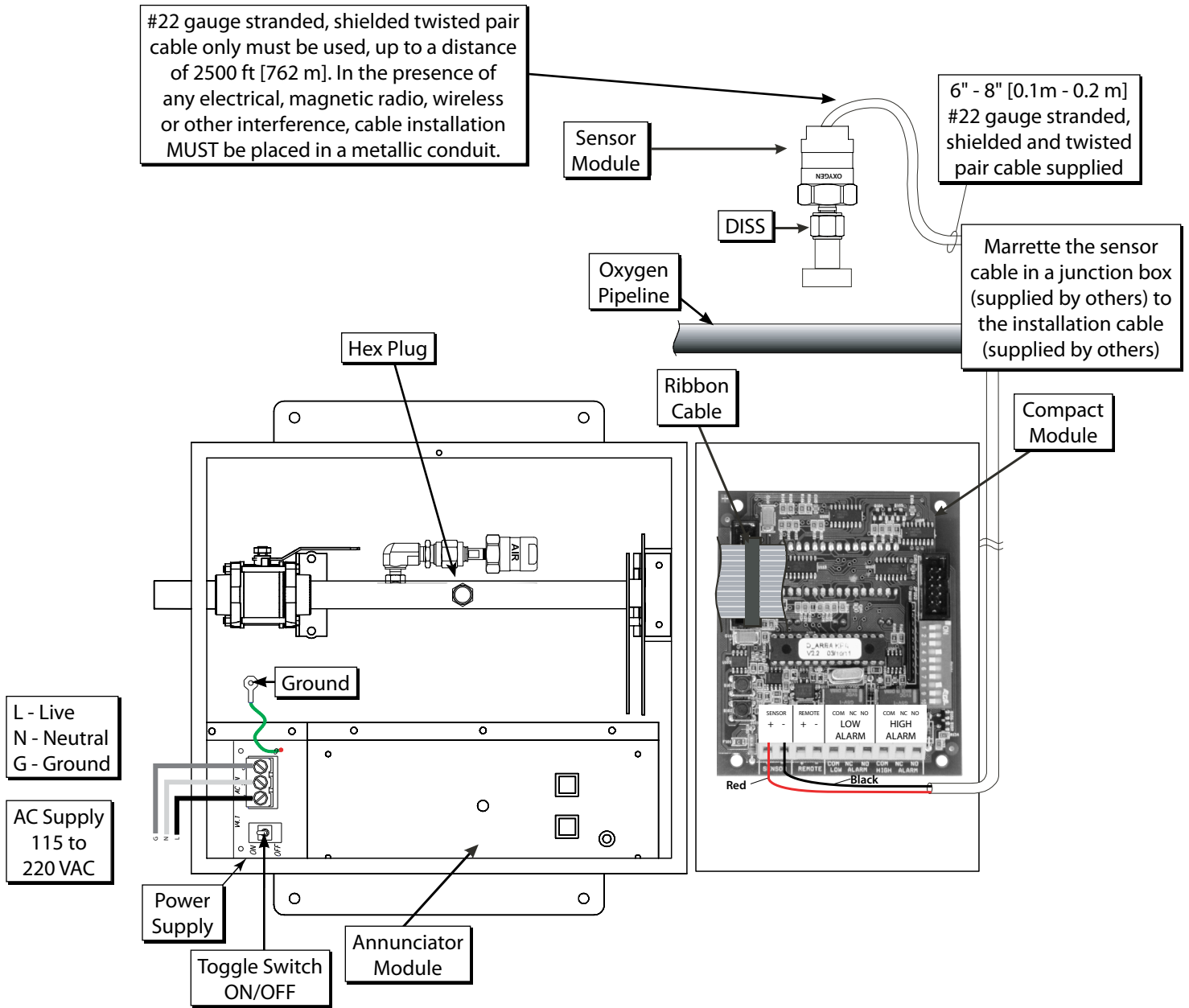

NOTE:

1. Do not ground the shield drain wire at sensor or inside the alarm panel back box.
2. Only a multi-conductor #22 gauge stranded, shielded as a bundle, and twisted-pair cable should be used for multiple sensors. It is not necessary for the cable to be individually shielded.



CAUTION: To protect from static electricity, ensure to discharge body static before installing the Medical Gas Alarm and sensors.

Appendix E

WIRING DIAGRAM: ALARM VALVE COMBO UNIT TO MASTER MODULE

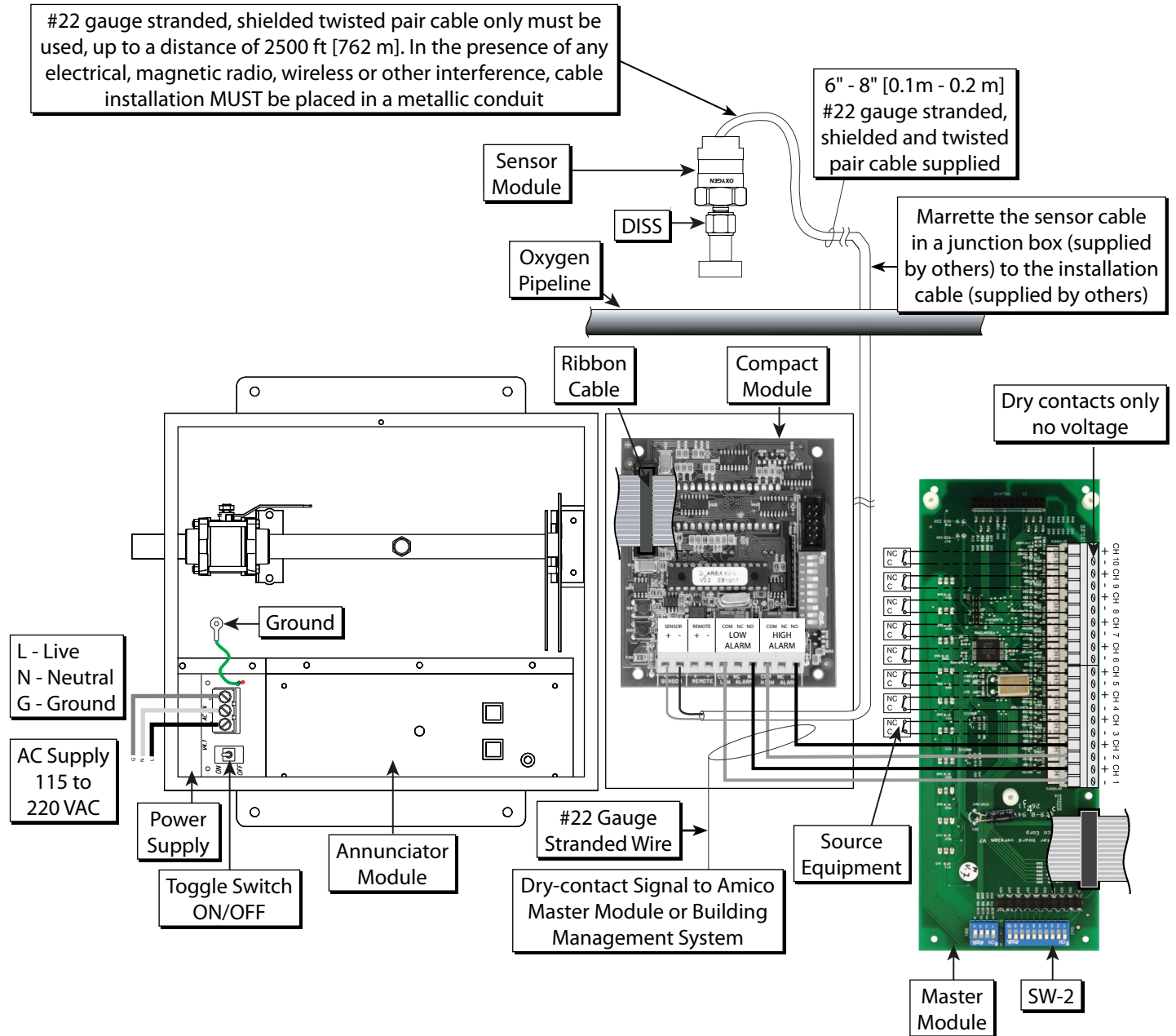

NOTE: Jumper any unused points on the Master module. Turn OFF dip-switches for any unused points (location SW-2).



CAUTION:

Source equipment signal wires must be connected to normally-closed dry contacts. No electrical voltage can be present and contacts must be closed during normal equipment operation. When contacts are open; an alarm condition will be activated.

Appendix F

TECHNICAL SPECIFICATIONS

Supply Voltage: 115 - 220 VAC, 50 - 60 Hz
Current Draw: 1 Amp. Max.
Fuse (1/4 * 1-1/4): Fast Blow 1 Amp.

Cable requirement:

AVC Display Module to Remote Sensor:

Important:

Cable: ONLY a #22 gauge stranded, shielded twisted pair cable must be used. (Belden # 8451 or equivalent.) In the presence of any electrical, magnetic, radio frequencies, wireless or other interference, cable installation MUST be placed in metallic conduit.

Distance: Maximum 2,500 feet [750 m]

Signal:	30 VDC	-	1.0 Amps.
	60 VDC	-	0.3 Amps.
	125 VAC	-	0.5 Amps.

AVC Display Module to Master Module:

Distance:	Maximum 10,000 ft [3,000 m]
Cable:	Minimum #22 gauge stranded wire (does not have to be shielded, twisted pair)
Signal:	5 VDC - < 5 μ A

NOTE:

For Master Alarm, source equipment signal wires must be connected to normally-closed dry contacts. No electrical voltage can be present and contacts must be closed during normal equipment operation. When contacts are open; an alarm condition will be activated.

Appendix G

WIRING

1. General Requirements

1. All wiring shall be protected from physical damage by raceways, cable trays or conduit in accordance with NFPA 70, National Electric Code or the Canadian Electrical Code.
2. All alarms are to be powered from the life safety branch of the emergency power system as required by applicable standards.
3. Alarm panel wires should be directly connected to switches or sensor as required by applicable standards.
4. All wire runs should be made with color coded wire. Record color, signal and source of signal for each wire lead to aid in connection of alarm finish components.
5. The alarm panel and remote sensors should not be installed near radio transmitters, electrical motors, electrical control room, switchgear, CT scanners, MRI machines or high voltage lines.
6. In the presence of any electrical, magnetic, radio frequencies, wireless or other interference, cable installation **MUST** be placed in metallic conduits.
7. No solid wire should be used for connecting sensors or master alarms to source equipment.
8. To protect from static electricity, ensure to discharge body static before installing the Medical Gas Alarm and Sensors.
9. Do not ground the shield drain wire at sensor or inside alarm panel back box
10. Electrical cable should not run below the sensor and behind the alarm box to protect from radio frequencies and EMI.

2. Low Voltage wire type, size and other requirements

All low voltage wiring must meet the following criteria:

1. #22 AWG stranded, shielded twisted pair wire **ONLY** must be used, rated for 300V and 60°C (140°F) minimum (Belden 8451 or equivalent).
2. Marrette the sensor cable in a junction box (supplied by others) to the installation cable (supplied by others) to protect from physical damage, radio frequencies and EMI.
3. Only a multi-conductor #22 gauge stranded, shielded as a bundle, and twisted-pair cable should be used for multiple sensors. It is not necessary for the cable to be individually shielded.

The following rules along with references to this manual's schematics clarify wiring requirements. Two conductor cables (must be #22 gauge stranded, shielded and twisted pair cable type) are required for each Gas Sensor module to the Gas Input board.

Notes

www.amico.com

Amico Corporation | 85 Fulton Way, Richmond Hill, ON L4B 2N4, Canada
600 Prime Place, Hauppauge, NY 11788, USA
Toll Free Tel: 1.877.462.6426 | Tel: 905.764.0800 | Fax: 905.764.0862
Email: info@amico.com | www.amico.com

ACP-IM-ALARM-VALVE-COMBO-UNIT 03.13.2023

