

# Stainless Steel Floor Pedestal



## General Specifications

The Floor Pedestal shall be an Amico Alert-1 series.

The floor pedestal shall be made of stainless steel with a #4 satin finish.

It shall be capable of holding medical gas outlets and electrical devices within the structure of the unit.

The electrical devices are provided with electrical boxes and 18" flex conduit and wire. Provided wire is #12, stranded copper THHN, 600 volt insulation (or RW90 XLPE, 600 volt insulation in Canada) for hot and neutral (black and white respectively). Grounds shall be #10, THHN (or Type R, RW90 XLPE in Canada) stranded copper wire (green). All ground conductors are installed in conduit. Receptacles will be installed with ground pin up.

There are (5) standard sizes to choose from:

- Small Shell - 12" x 10" x 20" (305 mm x 254 mm x 508 mm)
- Large Shell - 18" x 10" x 20" (457 mm x 254 mm x 508 mm)
- Short Pedestal - 7" x 10" x 20" (178 mm x 254 mm x 508 mm)
- Short Sloped - 10" x 16" x 23" (254 mm x 406 mm x 584 mm)
- Sloped Pedestal - 13" x 16" x 23" (330 mm x 406 mm x 584 mm)

The Floor Pedestal is rated for 120 to 240 V max, 50-60 Hz.

The Floor Pedestal is UL Listed to U.S. and Canadian safety standards.

## Features

- Stainless steel shell for aesthetic appearance.
- All devices and gas outlets are accessible through the access panel on the back of the pedestal or the removable top.
- Custom sizes are available upon request.

## Installation

Use four 3/8"-1/2" (9.53 cm - 12.7 cm) diameter mounting bolts (provided by contractor) to mount the pedestal securely on the finished floor. Remove the top cover and access panel for piping and wiring.

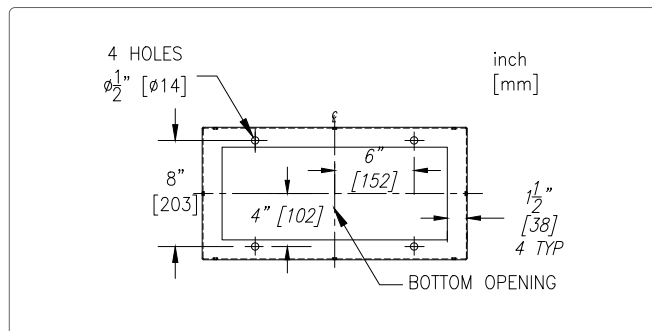

\*sample bottom opening size shown based on 10"Wx20"L pedestals

## Outlet Styles:

- DISS
- Chemetron
- Oxequip
- Puritan-Bennett
- Ohmeda

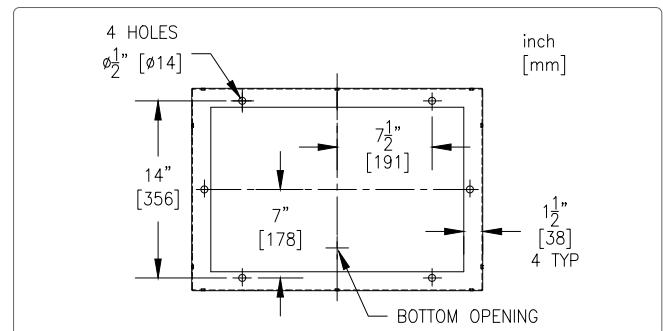

\*sample bottom opening size shown based on 16"Wx23"L pedestals







# Stainless Steel Floor Pedestal

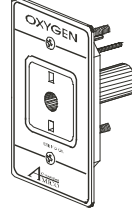
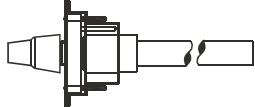

## Device & Accessory Chart

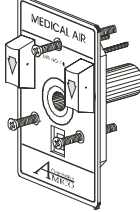
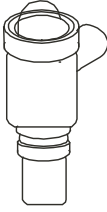
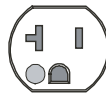
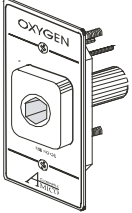
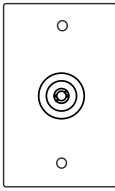
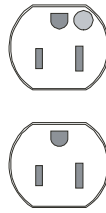
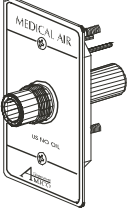
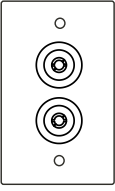
Please indicate the devices and/or accessories that will be installed on the floor pedestal, using the chart below.

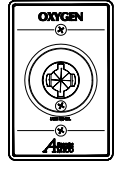
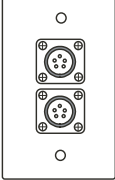
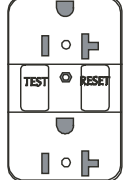
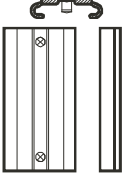
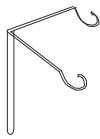
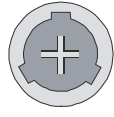
 <p><b>*QD XXX</b> Ohmeda/Medaes Compatible</p>	 <p><b>PE</b> Ceiling Column Passive Evacuation (19 mm/33 mm)</p>	 <p><b>E9-RED E10-IVORY</b> Duplex Receptacle 125V/20a (US/International)</p>	
 <p><b>CH XXX</b> Chemetron Compatible</p>	 <p><b>IMP</b> Passive Evacuation with Impedance Valve (19mm/22mm) (Side Mount Only)</p>	 <p><b>E11-RED E12-IVORY</b> Single Receptacle 125V/20a (US/International)</p>	
 <p><b>PB XXX</b> Puritan-Bennett Compatible</p>	 <p><b>GJ</b> Ground Jack Receptacle Single Bender (SLR-3) GREEN</p>	 <p><b>E5-RED E6-IVORY</b> Duplex Receptacle 125V/15a (CAN/International)</p>	
 <p><b>*DI XXX</b> DISS</p>	 <p><b>GJ2</b> Ground Jack Receptacle Dual Bender (SLR-3) GREEN</p>	 <p><b>E7-RED E8-IVORY</b> Single Receptacle 125V/15a (CAN/International)</p>	
 <p><b>OX XXX</b> Oxequip Compatible</p>	 <p><b>MJ</b> Monitor Jack Duplex (5-pin shown) Amphenol Model 10-825806-05S 97-14S-5S</p>	 <p><b>E13C-RED    E13-RED E14C-IVORY    E14-IVORY</b> Ground Fault Circuit Interrupter (C = Canadian)</p>	
 <p><b>SL</b> Vacuum Bottle Slide</p>	 <p><b>IV</b> Stainless Steel IV Hook (Duplex only)</p>	<p><b>DJ    DP</b> Data - Telephone Communication Jack or Duplex Receptacle (Provision Only) DP - Duplex Receptacle Provision</p>	 <p><b>TL</b> Twist-Lock Receptacle Hubble 23000-HG 125V/20a</p>

ALL ELECTRICAL DEVICES ARE HOSPITAL GRADE.

**NOTE:** CARBON DIOXIDE OUTLETS ARE NOT AVAILABLE IN PURITAIN-BENNETT. NITROGEN OUTLETS ARE ONLY AVAILABLE IN DISS.

Approval Signature

Date

Phone Number

# Stainless Steel Floor Pedestal



## Dimensions

**Small Floor Pedestal**

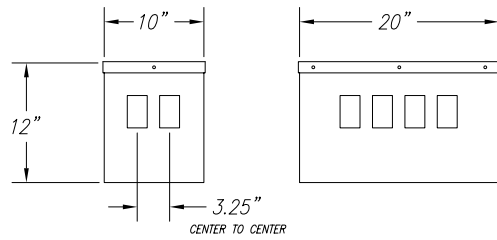

**Sloped Floor Pedestal**

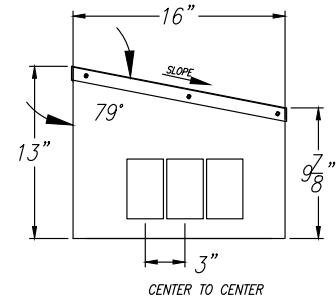

**Large Floor Pedestal**

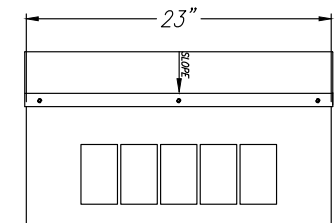
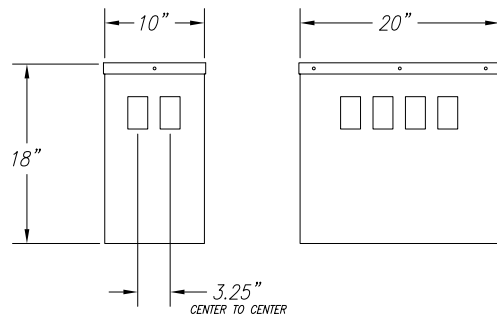

**Short Sloped Floor Pedestal**

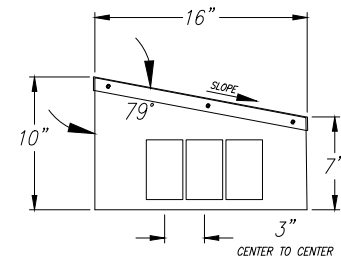

**Short Floor Pedestal**

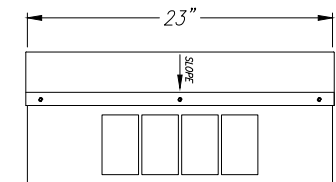
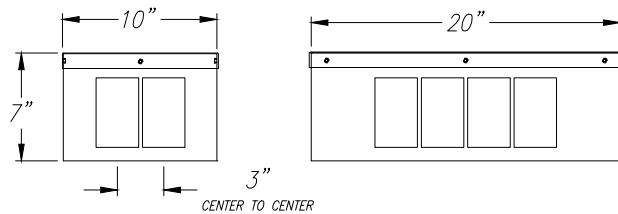

Project Name:

Distributed By:

# Stainless Steel Floor Pedestal



## Floor Pedestal & Equipment Selection

Use check box to select which Pedestal will be used and populate the diagram by indicating the locations of all required services.

**Small Floor Pedestal - W-PEDESTAL-12**

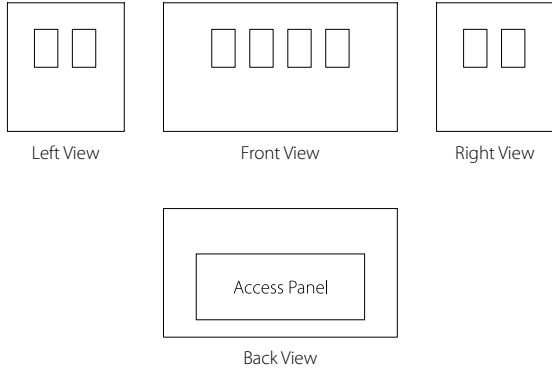

**Sloped Floor Pedestal - W-PEDESTAL-13**

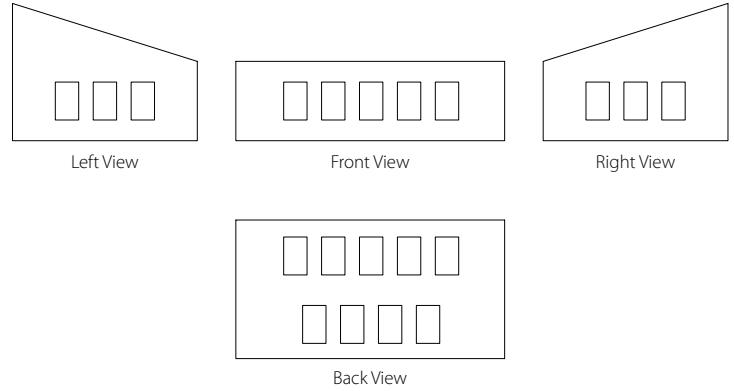

**Large Floor Pedestal - W-PEDESTAL-18**

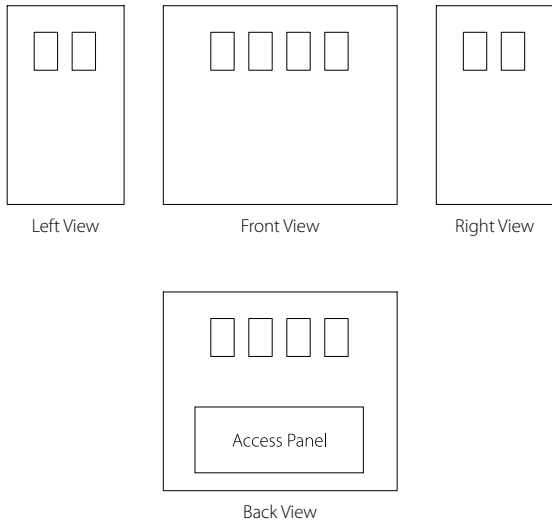

**Short Sloped Floor Pedestal - W-PEDESTAL-10**

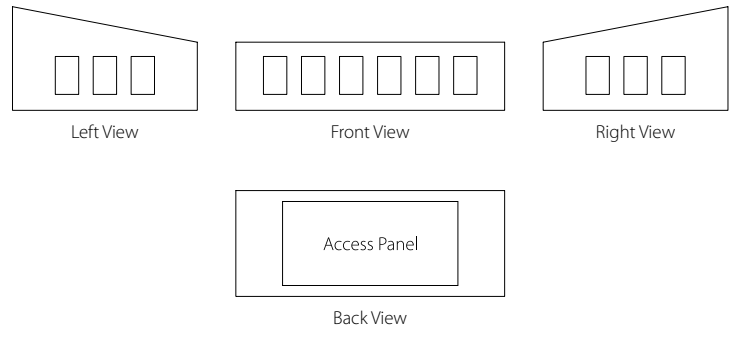

**Short Floor Pedestal - W-PEDESTAL-07**

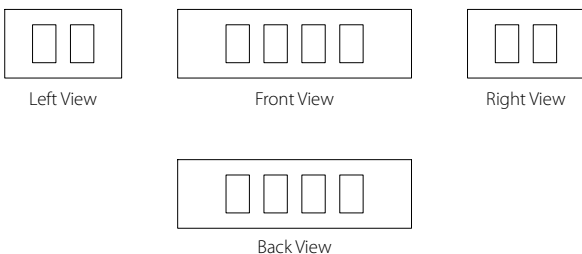

**Gas Legend**

<b>O</b>	Oxygen
<b>A</b>	Medical Air
<b>V</b>	Vacuum
<b>2</b>	Nitrous Oxide
<b>N</b>	Nitrogen
<b>C</b>	Carbon Dioxide
<b>W</b>	WAGD (US)
<b>E</b>	AGSS (Canada)